



## Product Features

- High power factor:  $PF \geq 0.95$
- Low Harmonic Distortion:  $THD < 10\%$
- Efficiency:  $> 85\%$
- Flicker-free parameters:  $Pst LM \leq 0.07$ ,  $SVM \leq 0.06$
- No load/Standby power  $< 0.5W$
- Anti-surge voltage: differential mode 1kV (L-N)
- Designed for CE-Erp compliance
- Over-heat /Over-load / Short circuit protection
- Suitable for Class II III fixtures



Flicker Free



## Advantages of the DB-40-XX-AS series products

- High conversion efficiency:  $> 85\%$  efficiency, low standby air consumption ( $< 0.5W$ ), compliant with energy efficiency regulations (CE-Erp)
- High-frequency exemption level: Supports high-frequency dimming above 4000 Hz, compliant with IEEE 1789 exemption standards
- Ultra-low energy consumption: Features an active PFC design with  $PF \geq 0.95$
- Safety protection: Class II insulation design and multiple protection functions
- High dimming accuracy: Smooth dimming without flicker from analogue signals, dimming range 0.1-100%

## Product Description

- 40W, 24V
- Constant voltage output,  
1CH 0/1-10V dimmable LED driver
- Compatible with 4 kinds of dimming signals: 0-10V,  
1-10V, 10V PWM resistor, Push switch
- Dimming range: 0.1-100%
- 5 years warranty

## Housing Features

- Housing material: Polycarbonate, white color
- Input wiring: Screw terminal
- Output wiring: Screw terminal
- Ingress protection: IP20, for indoor use

## Product Applications

- LED strips for indoor lighting
- Wall Washer for Hotel/Retail Lighting
- Panel lights for office/commercial lighting

## Model List

Model	Input voltage ~	Output voltage ≐	Output power	Power factor	Efficiency	Certification
DB-40-12-AS	220-240V	12V	40W	$\geq 0.95$	$> 85\%$	ENEC, TUV, CB, CE, RoHS, UKCA, ERP
DB-40-24-AS	220-240V	24V	40W	$\geq 0.95$	$> 85\%$	ENEC, TUV, CB, CE, RoHS, UKCA, ERP

## Model Naming Rule

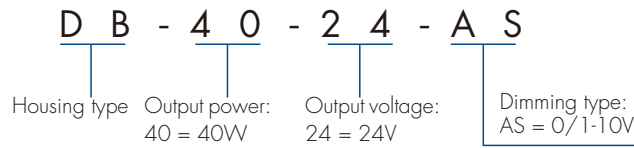

## Technical Parameters

Output parameter			
Item	Value	Unit	Note
Output Voltage	24 ±2.5%	VDC	-
Output Current	Max. 1.67	A	-
Output Power	Max. 40	W	-
Ripple & Noise	100	mV	-
PWM Frequency	4000	Hz	-
Start-up time	≤0.5	S	230VAC
Flicker-free	Pst LM≤0.07, SVM≤0.06	-	Measured using a constant-voltage LED strip. Refer to the "Char.Curve Figure 8"

Input parameter			
Item	Value	Unit	Note
Input Voltage Range	220~240	VAC	-
Frequency Range	50/60	Hz	-
Efficiency	>85	%	230VAC
Alternating Current	0.25 Max.	A	-
Power Factor	≥0.95	-	for 40W load refer to the "Char.Curve Figure3"
THD	<10	%	Full load, refer to the "Char.Curve Figure4"
Inrush Current	26.5	A	Cold start at 230VAC
Anti Surge	1	KV	diff. mode: L-N Acc. to IEC61000-4-5.1.2/50us,8/20us
Leakage Current	≤0.5	mA	-
No Load/Standby Power	<0.5	W	-

Operation Environment			
Item	Value	Unit	Note
Working Temperature	-20~45	°C	-
Tcase Max	85	°C	-
Working Humidity	20~90	%	non-condensing
Storage Humidity	10~95	%	-
Storage Temperature	-40~80	°C	-
Temperature Coefficient	±0.03	%/°C	0-50%
Vibration Resistance	10-500	Hz	2G, 6min/cycle, X,Y,Z axes/2min
IP Rating	IP20	-	-
Lifetime	50000	Hrs	@Tc 85°C, refer to the "Char.Curve Figure7"

Safety & EMC			
Item	Value	Unit	Note
Withstand Voltage	3750	VAC	I/P-O/P
Insulation Resistance	100/500/25/70	MΩ/VDC/°C/%RH	I/P-O/P
EMC Emission	EN55015, EN61000-3-2/-3, EN61547	-	-
EMC Immunity	EN61000-4-2.3.4.5.6.8.11, EN61547	-	-
Certifications	ENEC, TUV, CB, CE, RoHS, UKCA, ERP	-	-

### Certification Standards:

EN61347-1, EN61347-2-13, EN62493, EN62384, EN61547, EN55015, EN61000-3-2, EN61000-3-3

**Inrush current & MCB**

Item	Value	Unit	Note			
Inrush current	26.5	A	-			
Twighth	0.33	ms	-			
MCB type	B10	B16	C10	C16	pcs	-
	9	14	15	23		

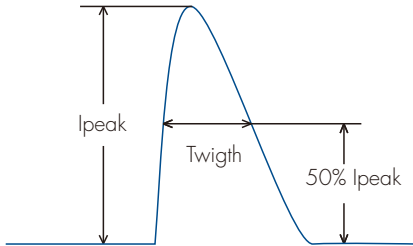

- The calculation is based on the parameters of the ABB S200 series of miniature circuit breakers.
- For miniature circuit breakers of different brands and models, the number of power supplies that can be connected varies.
- When the installation environment temperature of the MCB exceeds 30°C, or parallel connection installed, the number of connectable power supplies will also decrease, need recalculation.
- Type B MCB are suitable for household lighting, Type C MCB are suitable for commercial lighting.

**Insulation between circuits**

Insulation	Input	Output	Case	0/1-10V	PUSH
Input	-	SELV	SELV	Basic	-
Output	SELV	-	SELV	SELV	SELV
Case	SELV	SELV	SELV	SELV	SELV

**Basic insulation:** The minimum insulation required for the normal operation of the equipment, used to isolate energized parts from accessible parts (e.g., shells, parts that may be touched by the human body) and to prevent direct contact with electric shocks.

**Double insulation:** It is composed of basic insulation and additional insulation, forming two independent layers of insulation protection, even if one layer fails, the other layer can still prevent electric shock.

**Protection function**

Over Temperature: Current decrease when PCB temp >100°C, recovers automatically after fault condition is removed.

Short Circuit: Shut down the output voltage, recovers automatically after fault condition is removed.

**Dimming interface**

0/1-10V dimming: Dimming range 0-10V or 1-10V, dimming connector current consumption < 0.1mA, dimming curve refer to the "Char. curve Figure 5-6".

Push DIM dimming: Voltage range 220~240VAC 50/60Hz.

Dimming range: 0.1-100%

**Test Note**

If not specified, the above parameters are the result of testing at ambient temperature of 25°C, humidity of 50%, full load conditions.

The startup time is measured during a cold start. Ripple voltage is measured at full load using a constant voltage LED strip.

## Characteristic Curve

Figure 1

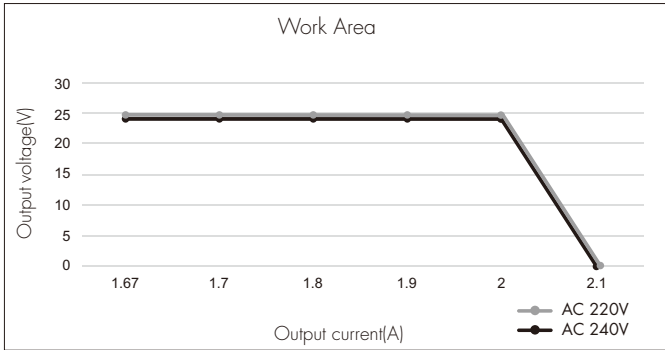

Figure 2

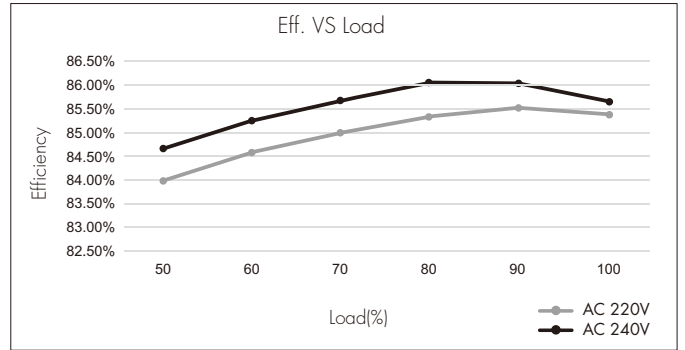

Figure 3

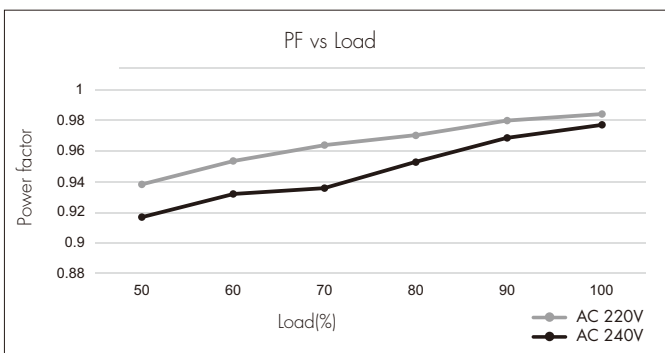

Figure 4

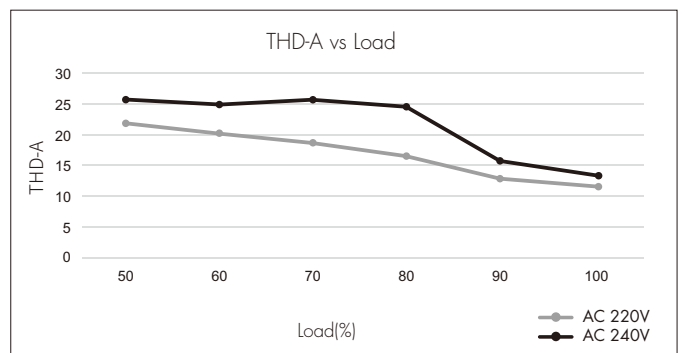

Figure 5

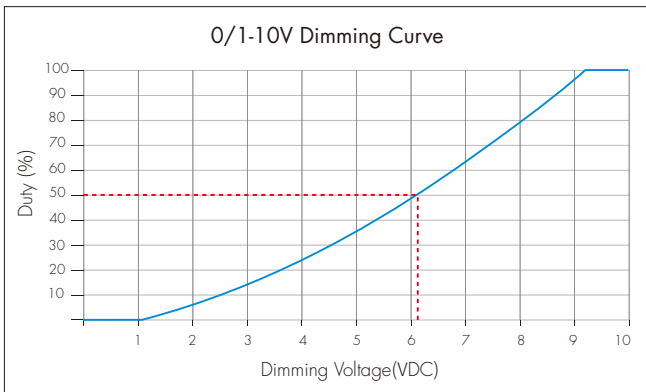

Figure 6

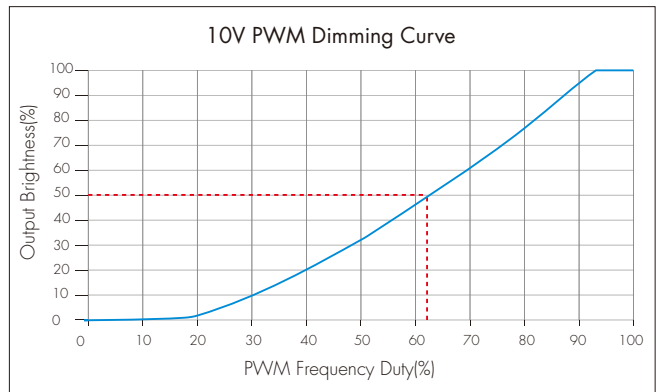

Figure 7

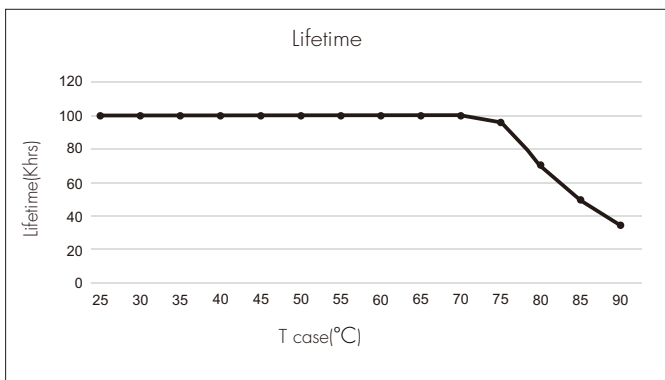
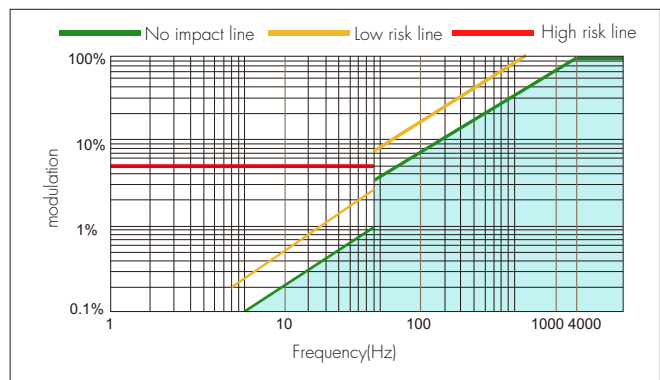

Figure 8



The relationship of the T<sub>c</sub> temperature also depends on the lighting fixture setting.

## Wiring Diagram

### • Wiring Instructions

Input/Output Wiring	Port Definition	Wire Diameter and Stripping Length
Input Wiring(PRI)	AC-L, AC-N AC Push switch input	Wire Diameter: 0.75-1.5mm <sup>2</sup> (18-16AWG) Stripping Length: 6-8mm
Output Wiring(SEC)	LED+, LED- 0/1-10V signal input	Wire Diameter: 0.5-1.5mm <sup>2</sup> (20-16AWG) Stripping Length: 6-8mm

Note: It is not recommended to use the 0/1-10V signal and the AC push switch at the same time for dimming control; the dimming function may become abnormal.

### 1. 0/1-10V Wiring

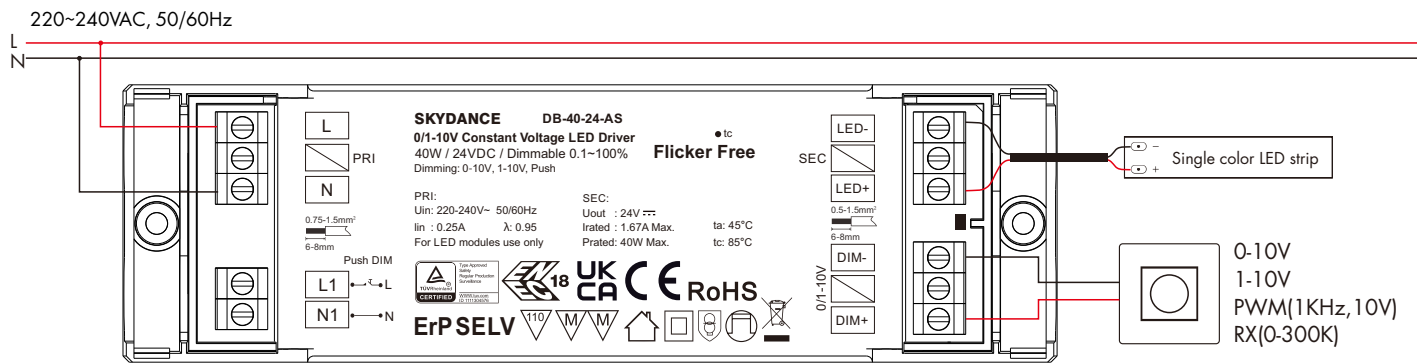

- 0/1-10V input can be connected to a wall switch 0/1-10V knob dimmer, or to the 0/1-10V signal output connector of a 0/1-10V dimming system.
- If push switch method was previously used for dimming, the 0/1-10V signal should be changed by more than 10% to return to the 0/1-10V dimming method.
- For consistent dimming, it is recommended to connect no more than 50 LED dimming drivers when the output signal current of the connected 0/1-10V dimmer is 20mA. When the output signal current of 0/1-10V dimmer is 50mA, it is recommended that the number of LED dimming driver connections should not exceed 100. The maximum wiring length from the dimmer to the LED dimming driver should not exceed 50m (copper wire with a cross-section of 0.75 mm<sup>2</sup> is used for wiring).

### 2. AC Push Switch Wiring

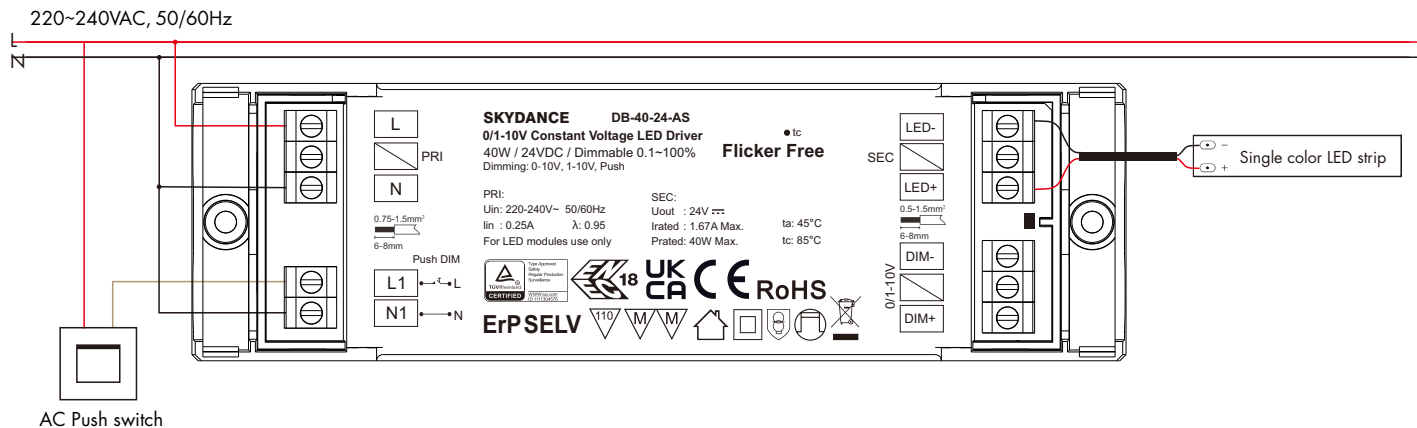

AC push switch function:

Short press: Turn on/off the light.

Long press(1-6s): Press and hold to step-less dimming, with every other long press, the light level goes to the opposite direction.

Dimming memory: Light returns to the previous dimming level when switched off and on again, even at power failure.

Synchronization: The push switch connector can be connected to the self-reset panel switch or the self-reset button to dim the light.

If more than one controller are connected to the same push switch, do a long press for more than 10s, then the system is synchronized and all lights in the group dim up to 100%.

## Installation Precautions

### 1. Hot plug-in

- Hot plug-in is not supported due to residual output voltage of > 0 V.
- If a load is connected, the device needs to be restarted.
- The restart can be achieved by reset or dimming interface (0/1-10V, Push DIM).

### 2. Wiring guidelines

- This product must be installed and adjusted by a qualified professional.
- Before you power on the product, please make sure all the wiring is correct in case of incorrect connection.
- PC covers, housings and plug light kits for power supplies assembled within the fixture are required to meet UL94-V0 and above fire ratings.
- The power supply is used as part of the luminaire system in conjunction with the end device (luminaire), and since the EMC performance is affected by the LEDs and the alignment.  
The end device manufacturer needs to re-verify the EMC of the complete unit.
- If a fault occurs, please do not attempt to fix the product by yourself; If you have any questions, please contact us in time.

### 3. Installation environment

- This product is non-waterproof.  
When installed outdoors, please ensure it is mounted in a water proof enclosure.
- This product should be installed in a dry, acid-free, oil-free environment.
- Please use the product within the operating temperature range of -20°C~45°C to ensure stable performance.
- LED driver should keep a certain distance from the heating stuff(such as the luminaries radiator).  
The installation interval between the product and the product is recommended to be 20cm, so as not to affect the service life due to poor heat dissipation(show in Figure).

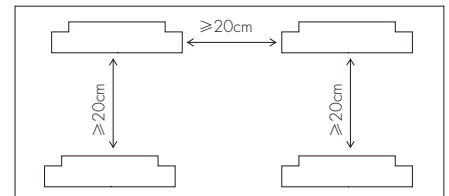

## Tc Point Location

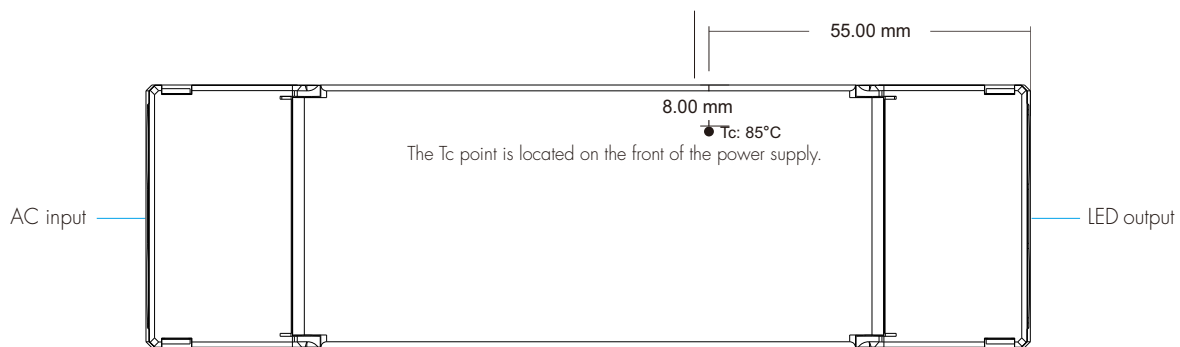

## Product Size and Packaging Information

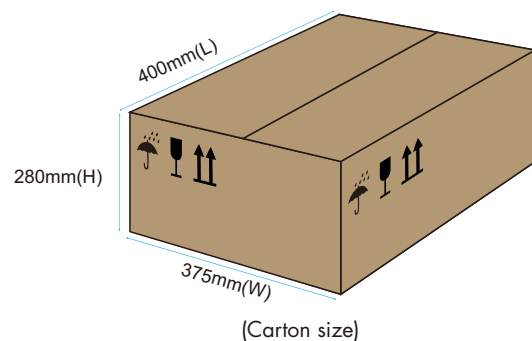
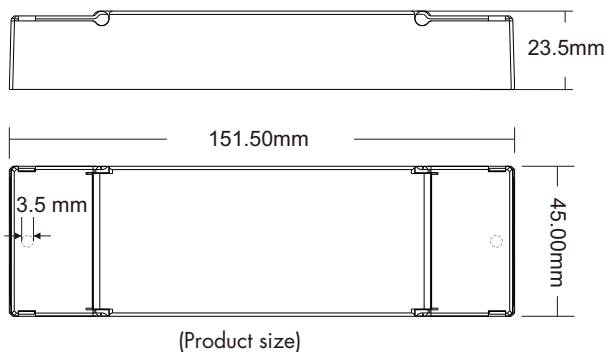

Model	Product size (mm)	White box size(mm)	N.W(pcs)	Carton size(mm)	Qty/carton	N.W/carton	G.W/carton
DB-40-24-AS	151.5*45*23.5(L*W*H)	175*54*27(L*W*H)	216g (±5g)	400*375*280	100pcs	21.6kg (±0.5kg)	24.4kg (±0.5kg)

## Version Log

Version	Update time	Update Content
1.0.0	2025.8.9	Original version

All information in this manual has been carefully reviewed. We reserve the right of final interpretation in the event of any typographical errors or misunderstanding of the content. If there is any improvement of the product, the relevant content will be revised to the new version of the manual simultaneously. Thanks for your support!