

PIR Sensor Stair Light Controller

- Dual PIR sensing + dual push switch 32 step stair light controller with daylight detection function.
- 32 channels constant voltage output drive low voltage LED strip, Max. 1A current per channel.
- OLED display screen, 3-buttons operate.
- 6 run modes are available: flow, chase, trail, float, five-step and one-step, with 1-8 levels of adjustable speed and brightness.
- Multiple steps can be set to synchronize or sequence on/off.
- 0-3 seconds on/off fade time selectable,
- 5 seconds -10 minutes auto-off delay time selectable.
- Two push switch can be connected for use as manual switch input.
- With fast self-testing function.
- Any damaged LED channel in 32 channels can be set disable.

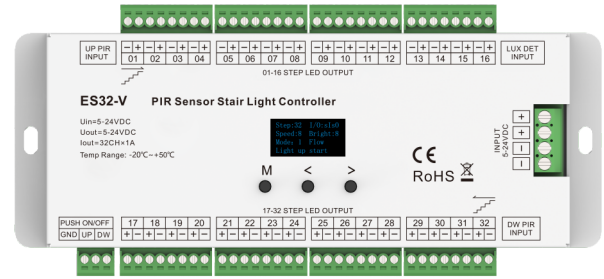

CE RoHS emc

Technical Parameters

Input and Output		Sensor data		Safety and EMC	
Input voltage	5-24VDC	Sensitive field	≤3m	EMC standard (EMC)	ETSI EN 301 489-1 V2.2.3
Output voltage	32 x (5-24)VDC	Sensitivity angle	30°(±10°)		ETSI EN 301 489-17 V3.2.4
Output current	32CH,1A/CH	Environment		Safety standard	EN 62368-1:2020+A11:2020
Output power	32 x (5-24)W	Operation temperature	Ta: -20°C ~ +55°C	Certification	CE,EMC,IVD
Output type	Constant voltage	Case temperature (Max.)	Tc: +85°C	Package	
Warranty		IP rating	IP20	Size	W213 x L130 x H45mm
Warranty	5 years			Gross weight	0.65kg

Mechanical Structures and Installations

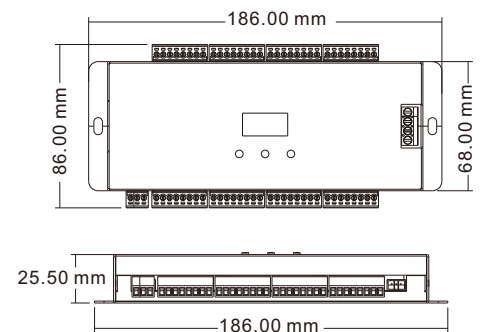
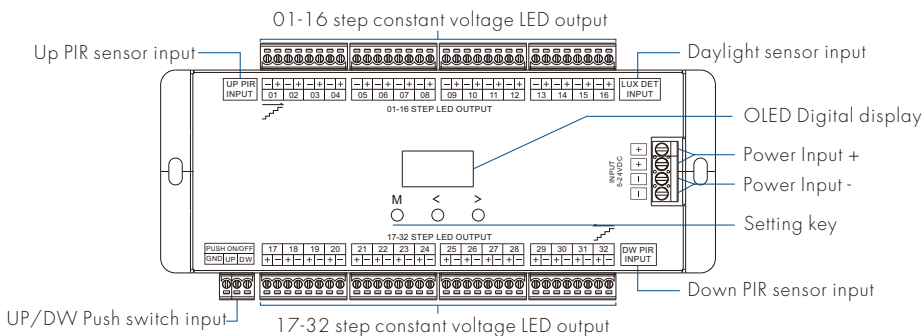

Wiring Diagram

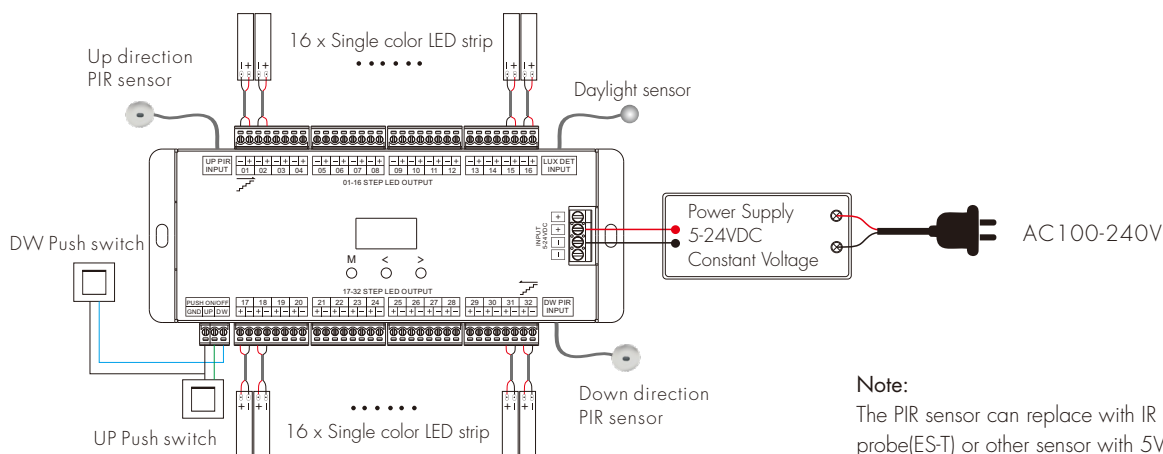

Note:
The PIR sensor can replace with IR reflection induction probe(ES-T) or other sensor with 5V level output.

OLED screen and key operations

- Long press M key for 2s, enter system parameters setting state: setting PWM frequency, ON/OFF fade time, daylight sensor threshold, sensor off delay time, push switch off delay time, system language selection.
- Short press M key, enter light effect parameter setting state: setting step number, turn on/off light mode, brightness and speed level, run mode.
- When in parameters setting state, short press M key to switch multiple parameters, press < or > key for parameters adjustment.
- Long press M key or wait 15s to quit parameter setting state.
- Long press M & > key for 2s, display "Light up test" on the 4 line of OLED screen, start up direction induction light testing.
- Long press M & < key for 2s, display "Light down test" on the 4 line of OLED screen, start down direction induction light testing.
- Long press < & > key for 2s, restore factory default parameters, jump to language select interface automatically, press < or > key to switch two languages (Chinese and English), press M key to exit language select interface.
- Long press < , > & M for 2s, enter 32 channels LED disable setting interface.
- When the controller is in induction state, the indication of inductive signal input ("Light up start" and "Light down start") is displayed first, and then the light on/off status is displayed.
If the current detected LUX value is greater than daylight sensor threshold, display "Light up off" or "Light down off" on the fourth line.

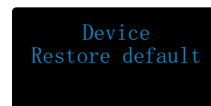

Restore Factory Settings Interface



Language Selection Interface

Main interface

Step: Set the number of steps, 04-32.

I/O: Setting the light on/off mode for multiple steps.

That is, sequential or synchronized light on/off, a total of four options.

Bright: Brightness level, 1-8, 8 is the maximum brightness.

Speed: Speed level, 1-8, 8 is the fastest speed.

Mode: Run mode number, 1-6.

Note: The light on/off mode setting is not valid when in Five-step and One-step mode.

Light on/off mode list:

Display	Name
sIs0	Sequential light on, sequential light off
sIc0	Sequential light on, synchronized light off
cIs0	synchronized light on, sequential light off
cIc0	synchronized light on, synchronized light off

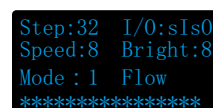

Light on/off state on the 4 line

Run mode list:

No.	Name
1	Flow (on one by one)
2	Chase (one on, one off, sequential move)
3	Trail (light-dark gradient, sequential move)
4	Float (dark-light-dark gradient, sequential move)
5	FiveStep (all off, five step on, sequential move)
6	OneStep (all on, one step off, sequential move)

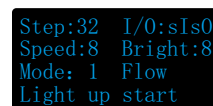

Inductive indication on the 4 line

System parameters setting

PWM freq: Set the three output PWM frequencies: 1KHz, 2KHz or 4KHz.

ON fade: Set 0s, 1s, 2s, 3s light on fade time.

OFF fade: Set 0s, 1s, 2s, 3s light off fade time.

Note:

light on/off fade is effective in flow mode;

only light off fade is effective in chase, trail and float mode when set to synchronised light off;

only light off fade is effective in five-step and one-step mode.

Lux Set: Daylight sensor threshold (10, 30, 50, 100, 150, 200lux, OFF),

with sufficient ambient light, the PIR sensor does not turn on the light.

Daylight sensor default off. The digital value after * is current detected LUX value.

Sen OFF Delay: Set auto-off light delay time at the end of sensing

(5sec, 10sec, 15sec, 20sec, 30sec, 1min, 3min, 5min, 10min, Cancel), default 10sec.

Push OFF Delay: Set auto-off light delay time after push to turn on light

(5s, 10s, 15s, 20s, 30s, 1min, 3min, 5min, 10min, cancel), default cancel.

Language: Change language, Chinese or English optional.

LED channel output disable setup

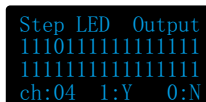

ch: the channel which is set
1: enable the channel to work
0: disable the channel

For example: If the fourth channel output is damaged, please long press M , < & > key 2s to enter LED disable interface, then change the corresponding channel(04) from 1(on) to 0(off). namely the damaged channel can be ignored.

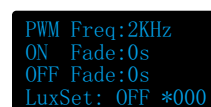

System Parameter Setting Interface 1

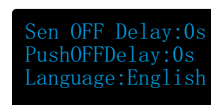

System Parameter Setting Interface 2

Factory set default parameters

Number of steps is 32, sequential light on, sequential light off, speed level is 6, brightness level is 8, run mode is Flow, PWM freq is 2KHz, on and off fade time is 0s, disable daylight sensor, sensor auto-off delay time is 10s, cancel push auto-off delay time, system language is English.

Induction switch control

Connect two PIR sensors to realize staircase light automatic sensing control:

- The upward PIR sensor is installed at the bottom of the staircase, when sensing a person, the light turns on automatically.
- The downward PIR sensor is installed at the top of the staircase, when sensing a person, the light turns on automatically.
- After the sensing light control process is finished, wait for the delay time, the light will automatically turn off.

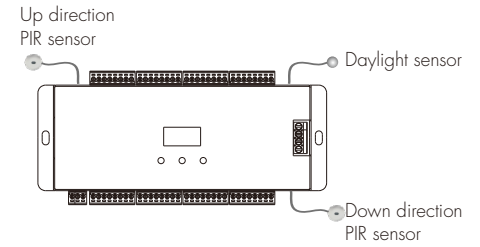

Manual switch control

Connect two push switch to realize staircase light manual control:

- The UP push switch is installed at the bottom of the staircase, short press the UP push switch to turn on or off the light, the fourth line of the OLED main interface display "Upward switch on" / "Switch off".
- The DW push switch is installed at the top of the staircase, short press the DW push switch to turn on or off the light, the fourth line of the OLED main interface display "Upward switch on" / "Switch off".
- When the light is on, press the push switch to turn off the light immediately. If it is in the delay light-off timing state, it will automatically cancel the delay light-off timing and turn off the light immediately.
- Push switch and PIR sensing can be used at the same time, after the PIR sensing turns on the light, the light can be turned off through the push switch.
- PIR sense detection is not active for 5 seconds before the push switch is operated.
- The push switch operation ignores the threshold setting of the daylight sensor.

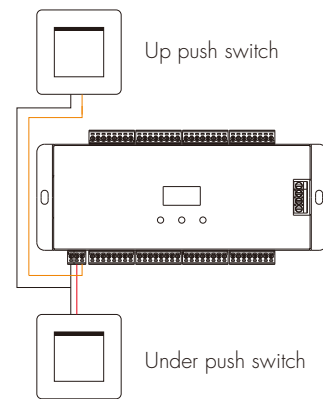

Installation of PIR sensor

Size of detector:

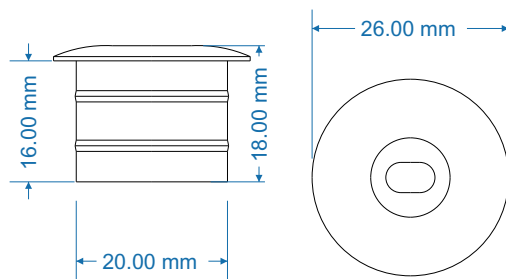

PIR sensor detection scope ($\pm 10^\circ$ Error):

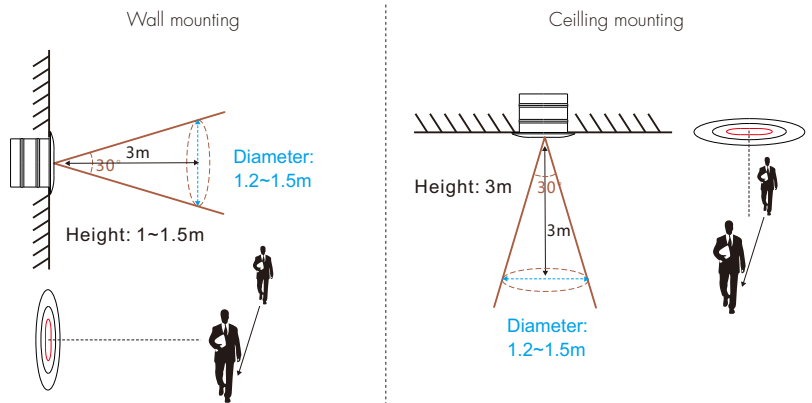

Notice for installation of PIR sensor

1. Recommended for wall mounting.
2. If the sensor is exposed to direct sunlight, interference signal will be introduced.
3. The sensor should be installed in a dry environment and keep away from windows, air conditioner and fans.
4. Make sure that the sensor stays away from heat source, such as countertops, kitchen appliances which generate hot steam, walls and windows in direct sunlight, air conditioner, heating, refrigerators, stoves and so on.
5. We recommended the wall-mounted installation height is 1-1.5 meters and the ceiling mounting height is no more than 3 meters.
6. There should not be shelter(screen, furniture, large bonsai) within the range of detection.

★ For wall mounting and ceiling mounting, note that the sensing holes are perpendicular to the direction of human movement.

Packing List



LED Controller
1 pcs

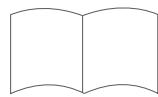

User Manual
1 pcs



Daylight sensor
(30cm)
1 pcs



PIR sensor
(1.2m)
2 pcs



PIR sensor
extension line (5m)
2 pcs



Slotted
screwdriver
1 pcs