

# TD1-4S, TD2-4S, TD3-4S, TD4-4S, TD5-4S



## Wall Mounted Touch Panel



TD1-4S  
Single color

TD2-4S  
Dual color

TD3-4S  
RGB

TD4-4S  
RGBW

TD5-4S  
RGB+CCT

- Touch panel 4 zone 1-5 color DALI master.
- 4 DALI address, support DT6 dimming, DT8-TC color temperature, DT8-RGB or DT8-RGBW.
- DALI-2 certified, in accordance with DALI standard protocol IEC 62386-101, 102, 208 and in compliance with DALI products from other international incorporation.
- Powered by DALI bus or 24VDC.
- Enable to select DALI address by encoding switch, support unicast, group and broadcast mode.
- Match with RF 2.4G four zone remote control optional.
- Ultra sensitive high strength glass touch panel with touch color slide.
- Smooth and accurate color adjustment by touching the color slide.
- 3 scenes memory.
- Touch keys with LED indicator.
- White & Black glass panel available.

### Technical Parameters

Input and Output		Dimming data		Safety and EMC	
Power supply	DALI bus/24VDC	Input signal	Touch key + RF 2.4GHz	EMC standard (EMC)	ETSI EN 301 489-1 V2.2.3
Static current	17mA@16VDC, 2mA@24VDC	RF Control distance	10m(Barrier-free space)	EMC standard (EMC)	ETSI EN 301 489-17 V3.2.4
Output signal	DALI	Dimming level	256 levels	Safety standard	EN 62368-1:2020+A11:2020
Environment		Dimming range	0 - 100%	Radio Equipment(RED)	ETSI EN 300 328 V2.2.2
Operation temperature	Ta: -20°C ~ +50°C	Package		Certification	CE, EMC, RED, DALI 2
Case temperature (Max.)	Tc: +65°C	Size	L112 x W112 x H50mm	Warranty	
IP rating	IP20	Gross weight	0.230kg	Warranty	5 years

### Mechanical Structures and Installations

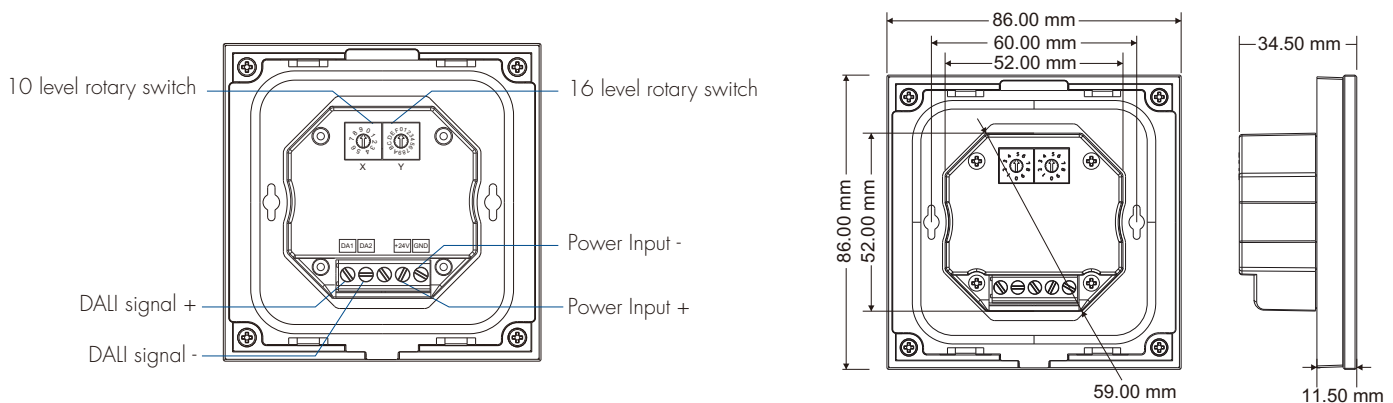

#### Installation diagram:

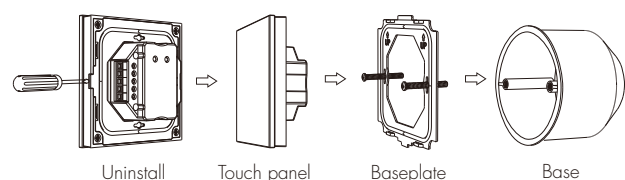

#### Typical base as below:

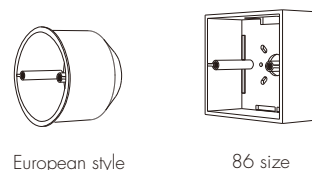

## Key function

### ● TD1-4S 4 zone single color panel

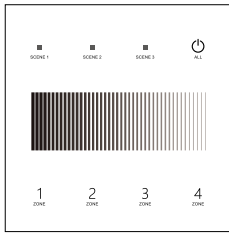

- Turn on/off all zone light.
- Short press recall the scene, long press 5s save current brightness into scene 1/2/3.
- Brightness slide.
- Short press turn on zone light and select zone simultaneously, long press 2s turn off zone light.
- Short press multiple zone key fastly, will select multiple zone synchronously.
- 4 zone control separately or synchronously.

### ● TD2-4S 4 zone dual color panel

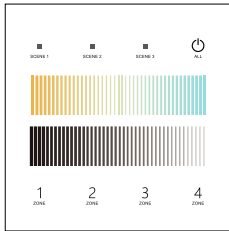

- Turn on/off all zone light.
- Short press recall the scene, long press 5s save current brightness into scene 1/2/3.
- Color temperature slide.
- Brightness slide.
- Short press turn on zone light and select zone simultaneously, long press 2s turn off zone light.
- Short press multiple zone key fastly, will select multiple zone synchronously.
- 4 zone control separately or synchronously.

### ● TD3-4S 4 zone RGB panel

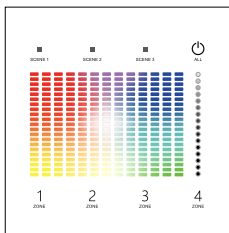

- Turn on/off all zone light.
- Short press recall the scene, long press 5s save current brightness into scene 1/2/3.
- Color slide.
- Brightness slide.
- Short press turn on zone light and select zone simultaneously, long press 2s turn off zone light.
- Short press multiple zone key fastly, will select multiple zone synchronously.
- 4 zone control separately or synchronously.

### ● TD4-4S 4 zone RGBW panel

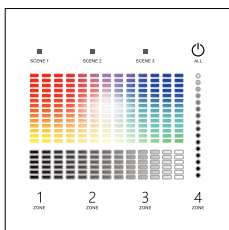

- Turn on/off all zone light.
- Short press recall the scene, long press 5s save current brightness into scene 1/2/3.
- Color slide.
- W channel brightness slide.
- Brightness slide.
- Short press turn on zone light and select zone simultaneously, long press 2s turn off zone light.
- Short press multiple zone key fastly, will select multiple zone synchronously.
- 4 zone control separately or synchronously.

### ● TD5-4S 4 zone RGB+CCT panel

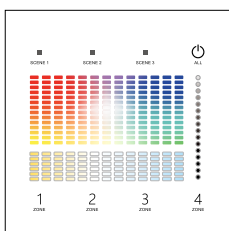

- Turn on/off all zone light.
- Short press recall the scene, long press 5s save current color into scene 1/2/3.
- Color slide.
- Color temperature slide.
- Brightness slide.
- Short press turn on zone light and select zone simultaneously, long press 2s turn off zone light.
- Short press multiple zone key fastly, will select multiple zone synchronously.
- 4 zone control separately or synchronously.

### Scene locking:

- Scene keys can be set to locked state, cancel long press for 5 seconds to save the scene function (default scene is not locked).
- Short press the panel on/off key, turn on the light first, then turn off the light, immediately long press the panel on/off key for 5 seconds, then immediately long press any one scene key for 5 seconds to set all scene keys to locked state.
- Short press the panel on/off key, turn on the light first, then turn off the light, immediately long press the panel on/off key for 5 seconds, then immediately long press any one scene key for 10 seconds to restore all scene keys to unlocked state.

# Wiring Diagram

## 1. Powered by DALI bus

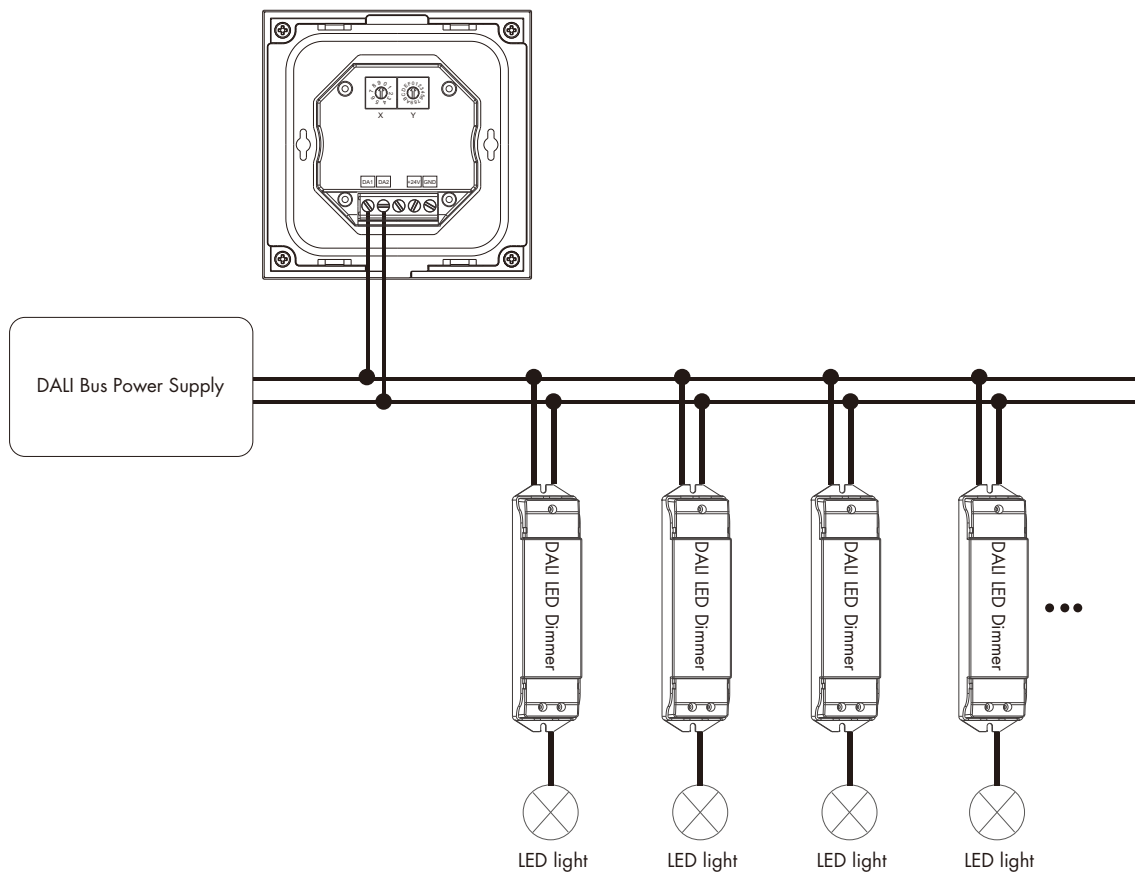

## 2. Powered by 24VDC

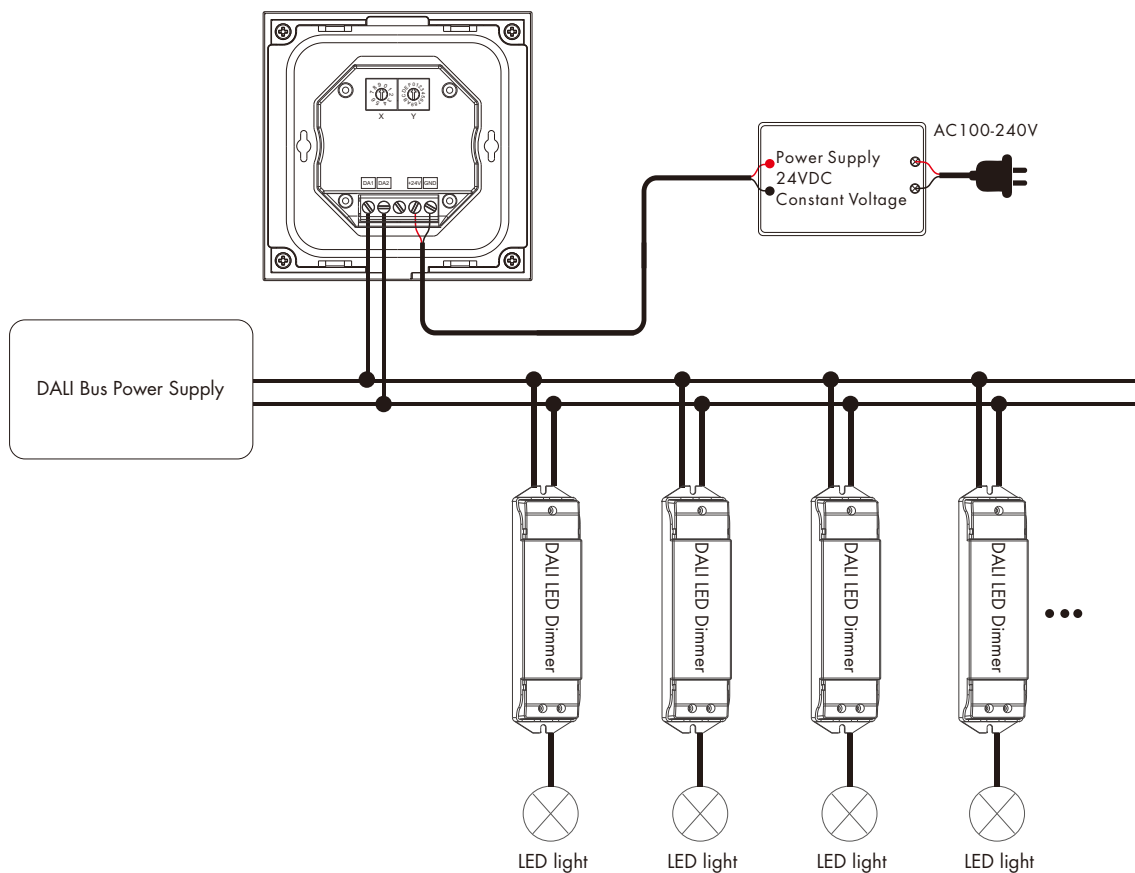

**Note:** It is recommended to use a 24VDC power supply for the touch panel DALI master to reduce the load on the DALI bus power supply.

## Touch Panel DALI master match RF remote

Touch panel DALI master can also match with RF 2.4G four zone remote (Optional).

End user can choose the suitable match/delete ways. Two options are offered for selection:

### Use On/Off key

Match:

Turn on light, turn off, immediately press the On/Off key of the panel for 5s, then press any zone key of the RF remote within 5s.

The LED indicator fast flash 3 times means match is successful.

Delete:

Turn on light, turn off, immediately press the On/Off key of the panel for 10s to delete all match,

The LED indicator fast flash 6 times means all matched remotes were deleted.

### Use Power Restart

Match:

Switch off the power of the panel, then switch on power, repeat again.

Immediately short press zone key 3 times on the remote.

The LED indicator fast flash 3 times means match is successful.

Delete:

Switch off the power of the panel, then switch on power, repeat again.

Immediately short press zone key 5 times on the remote.

The LED indicator fast flash 6 times means all matched remotes were deleted.

## DALI address setting

Address value =  $X * 10 + Y$ .

For example:  $X = 5, Y = 4$ , Address value =  $5 * 10 + 4 = 54$ .

### Unicast mode

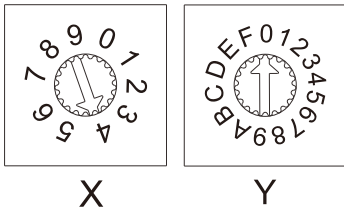

X is 0-6, Y is 0-9.

Address value 0-63 correspond to DALI unicast address 00-63.

For example:

Address value = 40, the unicast values of zone 1,2,3,4 are 40, 41, 42, 43.

Address value = 62, the unicast values of zone 1,2,3,4 are 62, 63, 0, 1.

### Group mode

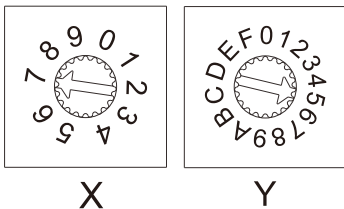

X is 7, Y is 0-F.

Address value 70-7F correspond to DALI group address 0-15.

For example:

Address value = 75, the group address value of zone 1,2,3,4 are 5, 6, 7, 8.

Address value = 7E, the group address value of zone 1,2,3,4 are 14, 15, 0, 1.

### Broadcast mode

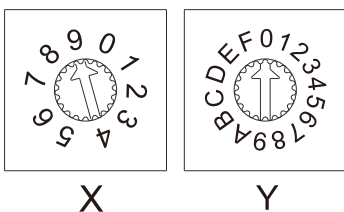

X is 9, Y is 0-F.

Address value 90 - 9F correspond to broadcast address.