

# V1-KC

## Rotary LED Dimmer



- Single channel constant voltage LED Rotary dimmer.
- 5 levels speed of light fade-in and fade-out effect can be set.
- 0-100% dimming smoothly without any flash.
- Logarithmic or linear dimming curve selectable.
- PWM frequency 500Hz, 2KHz, 8KHz or 16KHz selectable.
- Reverse protection.



CE RoHS

### Technical Parameters

Input and Output		Dimming data		Safety and EMC	
Input voltage	12-48VDC	Input signal	Rotary knob	EMC standard	EN IEC 55015/EN IEC 61547
Input current	8.5A	Dimming gray scale	256levels	Safety standard	EN 61347-1/-2
Output voltage	12-48VDC	Dimming range	0 - 100%	Certification	CE RoHS
Output current	8A@12-24V 6A@36-48V	Dimming curve	Logarithmic or linear	<b>Environment</b>	
Output power	96W@12V 192W@24V 216W@36V 288W@48V	PWM Frequency	500Hz, 2KHz, 8KHz, 16KHz	Operation temperature	Ta: -20°C ~ +55°C
Output type	Constant voltage	<b>Package</b>		Case temperature (Max.)	Tc: +85°C
<b>Warranty</b>		Size	L70 x W60 x H40mm	IP rating	IP20
Warranty	5 years	Gross weight	0.058kg		

### Mechanical Structures and Installations

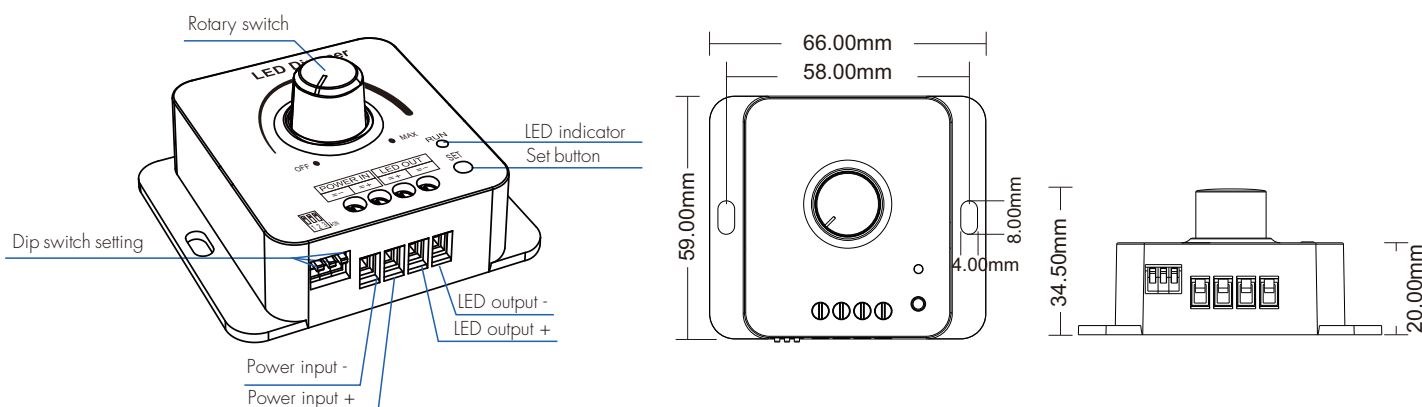

### Wiring Diagram

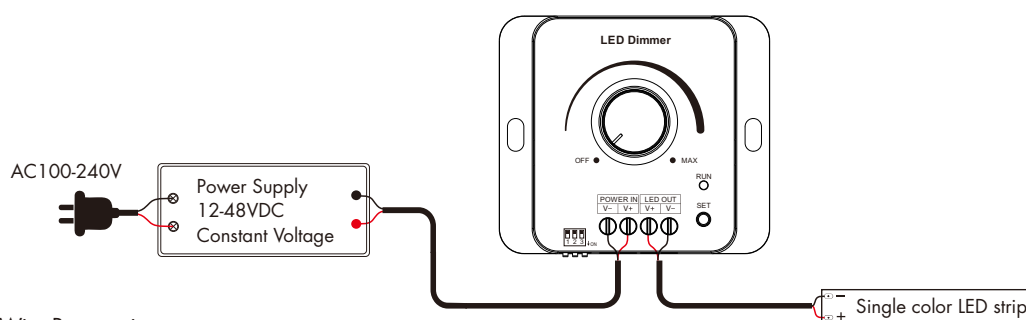

#### Wire Preparation:

1. The wiring can be solid or stranded with a cross-sectional area of 0.5 to 1.5 mm<sup>2</sup>.  
Conventional 1mm<sup>2</sup> can withstand 10A output current.
2. When wiring is installed, the terminals must be tightened.  
If they are not tightened, the contact point resistance will be too high  
and the terminals will easily burn due to heat when used at full load for a long time.

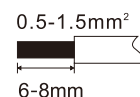

**Note:** The output power of a constant voltage power supply should be at least 1.2 times that of the output load (light strip), otherwise the full power output of the load can easily cause automatic flickering or shaking of the light.

## Dimming Operation

### Rotary dimming

Clockwise rotation increases brightness, counterclockwise rotation decreases brightness or turn off light.

### Set fade-in and fade-out dynamic effect





Short press the SET button to switch 5 levels fade speed in sequence.

- 1 second fade speed, the LED indicator blinks 1 time;
- 2 second fade speed, the LED indicator blinks 2 time;
- 5 second fade speed, the LED indicator blinks 3 time;
- 10 second fade speed, the LED indicator blinks 4 time;
- 30 second fade speed, the LED indicator blinks 5 time.

### Note:

1. In the fade-in and fade-out state, when adjust the brightness with the rotary switch, automatically exit the fade-in and fade-out state.
2. Each time rotate knob adjust the brightness and then set the fade-in and fade-out effect, the fade speed start from 1 second by default.
3. In the fade-in and fade-out state, if the knob adjustment is darker (<10%), the brightness will automatically increase to 10%.

## PWM Frequency Setting

 1	 2	 1	 2
500Hz	2KHz	8KHz	16KHz
8A	8A	6A	4A (12-24V)
6A	6A	4A	3A (36-48V)

We can select four PWM frequency: 500Hz, 2KHz, 8KHz or 16KHz.  
Higher PWM frequency, will cause lower output current, higher power noise, but more suitable for camera(No flickers for video).

## Dimming Curve Setting

Logarithmic dimming curve

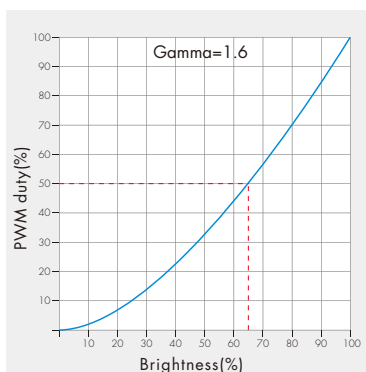

Linear dimming curve

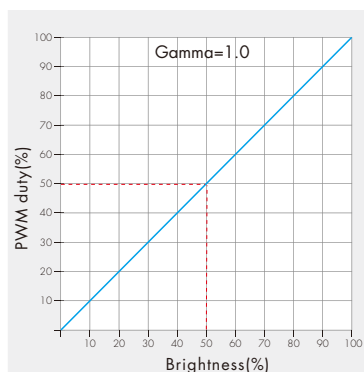

## Installation Precautions

1. The distance between the products should be  $\geq 20\text{cm}$ , so as not to affect lifespan of the products due to poor heat dissipation.
2. The product shall not be installed close to the switching power supply with an interval of  $\geq 20\text{cm}$  to avoid radiation interference of the switching power supply.