







DALI Constant Voltage LED Controller

Model Name	Product Name	Pictrue	Parameters	Key Feature	Recommended Products	Distinguish Between Similar Products
DA1	DALI DT6 1 Channel Constant Voltage LED Dimmer (DIM)		Input voltage:12-48VDC Output voltage:12-48VDC Output current:15A@12/24V 10A@36/48V Input signal:DALI,Push Switch Dimming curve:Logarithmic Proudct size:175x45x27mm(LxWxH)	<ul style="list-style-type: none"> ● 1 DALI address,1 channel constant voltage output. ● DALI address will be automatically assigned by DALI master. ● Connect with external push switch to achieve on/off and dimming function. 	DALI PC Host:Assign DALI address, dimming ontrol DALI Master Control Panel:TD1-S, TD1-4S, TD-K, TS4-D WiFi APP Control:DA-M(WT), TD-K(WT) Zigbee Control:DA-M(WZ), TD-K(WZ)	/
DA1-S	DALI DT6 1 Channel Constant Voltage LED Dimmer (DIM)		Input voltage:12-48VDC Output voltage:12-48VDC Output current:8A Input signal:DALI,Push Switch Dimming curve:Logarithmic Proudct size:97x33x18mm(LxWxH)	<ul style="list-style-type: none"> ● 1 DALI address,1 channel constant voltage output. ● DALI address will be automatically assigned by DALI master. ● 3 kinds of PWM frequency by SET key setting: 2KHz, 8KHz, 16KHz. ● DALI port can connect AC push switch to achieve on/off and dimming function. 	DALI PC Host:Assign DALI address, dimming ontrol DALI Master Control Panel:TD1-S, TD1-4S, TD-K, TS4-D WiFi APP Control:DA-M(WT), TD-K(WT) Zigbee Control:DA-M(WZ), TD-K(WZ)	/
DA4	DALI DT6 4 Channel Constant Voltage LED Dimmer (DIM)		Input voltage:12-48VDC Output voltage:12-48VDC Output current:4x5A@12/24V 4x3A@36/48V Input signal:DALI Dimming curve:Logarithmic Proudct size:175x45x27mm(LxWxH)	<ul style="list-style-type: none"> ● 4 DALI address,4 channel constant voltage output. ● DALI address will be automatically assigned by DALI master. 	DALI PC Host:Assign DALI address, dimming ontrol DALI Master Control Panel:TD1-S, TD1-4S, TD-K WiFi APP Control:DA-M(WT), TD-K(WT) Zigbee Control:DA-M(WZ), TD-K(WZ)	DA4, DA4-M, DA4-L Contrast: Common: 4-channel constant voltage output with the same work voltage and output current. Difference:
DA4-M	DALI DT6/DT8 4 Channel Constant Voltage LED Dimmer (DIM/CCT/RGB/RGBW)		Input voltage:12-48VDC Output voltage:4x(12-48)VDC Output current:4x5A@12/24V 4x3A@36/48V Input signal:DALI Dimming curve:Logarithmic Proudct size:175x45x27mm(LxWxH)	<ul style="list-style-type: none"> ● 1 DALI address,4 channel constant voltage output. ● DALI address will be automatically assigned by DALI master. ● Set DIM/CCT/RGB/RGBW 4 light type by DIP switch. 	DALI PC Host:Assign DALI address, dimming ontrol DALI Master Control Panel:TD1-S, TD1-4S, TD-K WiFi APP Control:DA-M(WT), TD-K(WT) Zigbee Control:DA-M(WZ), TD-K(WZ)	1. Different ways to assign addresses: DA4, DA4-M addresses can only be assigned by the DALI master (connected computer). DA4-L can be manually assigned and shown in digital display or automatically assigned by DALI master. 2. DALI type is different: DA4 can only be DT6 type(DIM), DA4-M switching of DT6/DT8 types by DIP switch, DA4-L switching of DT6/DT8 types by push buttons.
DA4-L	DALI DT6/DT8 4 Channel Constant Voltage LED Dimmer (DIM/CCT/RGB/RGBW)		Input voltage:12-48VDC Output voltage:4x(12-48)VDC Output current:4x5A@12/24V 4x3A@36/48V Input signal:DALI/AC Push Switch Dimming curve:Logarithmic Proudct size:170x50x23mm(LxWxH)	<ul style="list-style-type: none"> ● 1-4 DALI address,4 channel constant voltage output. ● Digital display,3 button setting. ● DALI address can be manually assigned and shown in digital display or automatically assigned by DALI master. ● Press the button to switch DIM/CCT/RGB/RGBW light type. ● When DT6(DIM) dimming, supports 1-4 DALI addresses, 4 channel independent control. ● When DT8(CCT/RGB/RGBW) dimming, only need 1 DALI address. ● PWM frequency 1K, 2K, 4K, 8K, 16KHz selectable. ● DALI port can connect AC push switch to achieve on/off and dimming function. 	DALI PC Host:Assign DALI address, dimming ontrol DALI Master Control Panel:TD1-S, TD1-4S, TD-K WiFi APP Control:DA-M(WT), TD-K(WT) Zigbee Control:DA-M(WZ), TD-K(WZ)	3. The controls are different: DA4, DA4-M Can only be controlled by the DALI master. The DA4-L can also be controlled by a push switch in addition to the DALI master control.
DA4-D	DALI DT6/DT8 4 Channel Constant Voltage LED Dimmer (DIM/CCT/RGB/RGBW)		Input voltage:12-24VDC Output voltage:4x(12-24)VDC Output current:4x5A@12/24V Input signal:DALI/AC Push Switch Dimming curve:Logarithmic Proudct size:48x110x67mm(LxWxH)	<ul style="list-style-type: none"> ● 1-4 DALI address,4 channel constant voltage output. ● Digital display,3 button setting. ● DALI address can be manually assigned and shown in digital display or automatically assigned by DALI master. ● Press the button to switch DIM/CCT/RGB/RGBW light type. ● When DT6(DIM) dimming, supports 1-4 DALI addresses, 4 channel independent control. ● When DT8(CCT/RGB/RGBW) dimming, only need 1 DALI address. ● PWM frequency 1K, 2K, 4K, 8K, 16KHz selectable. ● DALI port can connect AC push switch to achieve on/off and dimming function. ● Standard rail mount. 	DALI PC Host:Assign DALI address, dimming ontrol DALI Master Control Panel:TD1-S, TD1-4S, TD-K WiFi APP Control:DA-M(WT), TD-K(WT) Zigbee Control:DA-M(WZ), TD-K(WZ)	DA4-L, DA4-D Contrast: Common: 1. 4-channel constant voltage output, DALI address can be set by key and digital display. Difference: 1. Different input/output voltages: DA4-L input/output voltages:12-48V DA4-D input/output voltages:12-24V 2. Installation is different: DA4-L for conventional mounting, DA4-D for rail type mounting.
DA4-WPS	IP67 Waterproof DALI DT6/DT8 4 Channel Constant Voltage LED Dimmer (DIM/CCT/RGB/RGBW)		Input voltage:12-48VDC Output voltage:4x(12-48)VDC Output current:4x5A@12/24V 4x3A@36/48V Input signal:DALI Dimming curve:Logarithmic IP rating:IP67 Proudct size:153x57x34mm(LxWxH)	<ul style="list-style-type: none"> ● 1-4 DALI address,4 channel constant voltage output. ● Digital display,4 button setting. ● DALI address can be manually assigned and shown in digital display or automatically assigned by DALI master. ● Press the button to switch DIM/CCT/RGB/RGBW light type. ● When DT6(DIM) dimming, supports 1-4 DALI addresses, 4 channel independent control. ● When DT8(CCT/RGB/RGBW) dimming, only need 1 DALI address. ● PWM frequency 1000/2000/4000/8000Hz selectable. ● Waterproof IP67, for outdoor use. 	DALI PC Host:Assign DALI address, dimming ontrol DALI Master Control Panel:TD1-S, TD1-4S, TD-K WiFi APP Control:DA-M(WT), TD-K(WT) Zigbee Control:DA-M(WZ), TD-K(WZ)	DA4-WPS, DA4-L Contrast: Common: 1. 4-channel constant voltage output with the same work voltage and output current, DALI address can be assigned by key and digitally displayed. Difference: 1. Different waterproof rating: DA4-L IP ratin:IP20 DA4-WPS IP ratin:IP67(for outdoor use)

DALI Constant Current LED Controller

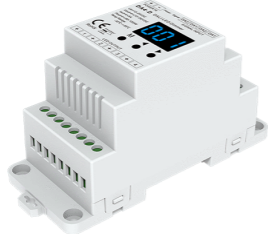
Model Name	Product Name	Pictrue	Parameters	Key Feature	Recommended Products	Distinguish Between Similar Products
DA4-C (150-500mA)	DALI DT6/DT8 4 Channel Constant Current LED Dimmer (DIM/CCT/RGB/RGBW)		Input voltage:12-48VDC Output voltage:4x(3-45)VDC Output current:4CH,150-500mA/CH Input signal:DALI Dimming curve:Logarithmic Proudct size:170x50x23mm(LxWxH)	<ul style="list-style-type: none"> ● 1-4 DALI address,4 channel constant voltage output. ● Digital display,3 button setting. ● DALI address can be manually assigned and shown in digital display or automatically assigned by DALI master. ● Press the button to switch DIM/CCT/RGB/RGBW light type. ● When DT6(DIM) dimming, supports 1-4 DALI addresses, 4 channel independent control. ● When DT8(CCT/RGB/RGBW) dimming, only need 1 DALI address. 	DALI PC Host:Assign DALI address, dimming ontrol DALI Master Control Panel:TD1-S, TD4-S, TD-K, TS4-D WiFi APP Control:DA-M(WT), TD-K(WT) Zigbee Control:DA-M(WZ), TD-K(WZ)	/
DA4-C (350-1200mA)	DALI DT6/DT8 4 Channel Constant Current LED Dimmer (DIM/CCT/RGB/RGBW)		Input voltage:12-48VDC Output voltage:4x(3-45)VDC Output current:4CH,350-1200mA/CH Input signal:DALI Dimming curve:Logarithmic Proudct size:170x50x23mm(LxWxH)	<ul style="list-style-type: none"> ● 1-4 DALI address,4 channel constant voltage output. ● Digital display,3 button setting. ● DALI address can be manually assigned and shown in digital display or automatically assigned by DALI master. ● Press the button to switch DIM/CCT/RGB/RGBW light type. ● When DT6(DIM) dimming, supports 1-4 DALI addresses, 4 channel independent control. ● When DT8(CCT/RGB/RGBW) dimming, only need 1 DALI address. 	DALI PC Host:Assign DALI address, dimming Control DALI Master Control Panel:TD1-S, TD4-S, TD-K, TS4-D WiFi APP Control:DA-M(WT), TD-K(WT) Zigbee Control:DA-M(WZ), TD-K(WZ)	/





DALI AC Triac Dimmer

Model Name	Product Name	Pictrue	Parameters	Key Feature	Recommended Products	Distinguish Between Similar Products
DT	DALI AC Triac Dimmer		Input voltage:100-240VAC Output voltage:100-240VAC Output current:Max 1.5A Input signal:DALI, AC Push Switch Dimming curve:Linear Proudct size:187x46x22mm(LxWxH)	<ul style="list-style-type: none"> ● 1 DALI address,1 channel output. ● Digital display,2 button setting. ● DALI address can be manually assigned and shown in digital display or automatically assigned by DALI master. ● Reverse-phase dimming or forward-phase dimming selectable. ● Connect with external push switch to achieve on/off and dimming function. 	DALI PC Host:Assign DALI address, dimming ontrol DALI Master Control Panel:TD1-S, TD4-S, TD-K, TS4-D WiFi APP Control:DA-M(WT), TD-K(WT) Zigbee Control:DA-M(WZ), TD-K(WZ)	/
DT-B	DALI AC Triac Dimmer		Input voltage:100-240VAC Output voltage:100-240VAC Output current:Max 1.5A Input signal:DALI Dimming curve:Linear Proudct size:52x52x26mm(LxWxH)	<ul style="list-style-type: none"> ● 1 DALI address,1 channel output. ● DALI address will be automatically assigned by DALI master. ● forward-phase dimming. 	DALI PC Host:Assign DALI address, dimming ontrol DALI Master Control Panel:TD1-S, TD4-S, TD-K, TS4-D WiFi APP Control:DA-M(WT), TD-K(WT) Zigbee Control:DA-M(WZ), TD-K(WZ)	/
DT-D	DALI AC Triac Dimmer		Input voltage:100-240VAC Output voltage:100-240VAC Output current:Max 1.5A Input signal:DALI, AC Push Switch Dimming curve:Linear/Logarithmic Proudct size:48x110x67mm(LxWxH)	<ul style="list-style-type: none"> ● 1 DALI address,1 channel output. ● Digital display,2 button setting. ● DALI address can be manually assigned and shown in digital display or automatically assigned by DALI master. ● Reverse-phase dimming or forward-phase dimming selectable. ● Linear dimming or logarithmic dimming selectable. ● Connect with external push switch to achieve on/off and dimming function. ● Standard rail mount. 	DALI PC Host:Assign DALI address, dimming ontrol DALI Master Control Panel:TD1-S, TD4-S, TD-K, TS4-D WiFi APP Control:DA-M(WT), TD-K(WT) Zigbee Control:DA-M(WZ), TD-K(WZ)	/



DALI 0/1-10V Dimmer

Model Name	Product Name	Pictrue	Parameters	Key Feature	Recommended Products	Distinguish Between Similar Products
DV	DALI 0/1-10V Dimmer		Input voltage:100-240VAC Input signal:DALI Output signal:2x(0/1-10)V, 20mA/CH Relay output:Max. 5A Proudct size:187x46x22mm(LxWxH)	<ul style="list-style-type: none"> ● 2 DALI address,2 channel 0/1-10V output. ● Digital display,2 button setting. ● DALI address can be manually assigned and shown in digital display or automatically assigned by DALI master. ● High voltage AC input, one high voltage AC relay output. ● 0-10V or 1-10V output selectable. 	DALI PC Host:Assign DALI Address, Dimming Control DALI Master Control Panel:TD1-S, TD4-S, TD-K, TS4-D WiFi APP Control:DA-M(WT), TD-K(WT) Zigbee Control:DA-M(WZ), TD-K(WZ)	/
DV1	DALI 0/1-10V Dimmer		Input voltage:100-240VAC Input signal:DALI Output signal:0/1-10V, 20mA Relay output:10A resistive load 8A incandescent 5A inductive load Proudct size:131x37x20.5mm(LxWxH)	<ul style="list-style-type: none"> ● 1 DALI address,1 channel 0/1-10V output. ● DALI address will be automatically assigned by DALI master. ● 10A dry contact mains rated relay output. ● 0-10V or 1-10V output selectable. 	DALI PC Host:Assign DALI Address, Dimming Control DALI Master Control Panel:TD1-S, TD4-S, TD-K, TS4-D WiFi APP Control:DA-M(WT), TD-K(WT) Zigbee Control:DA-M(WZ), TD-K(WZ)	/

DALI AC Switch







Model Name	Product Name	Pictrue	Parameters	Key Feature	Recommended Products	Distinguish Between Similar Products
DH	DALI AC Switch		Input voltage:100-240VAC Output signal:100-240VAC Relay output:2CH, 5A/CH Proudct size:187x46x22mm(LxWxH)	<ul style="list-style-type: none"> ● 2 DALI address,2 channel output. ● Digital display,2 button setting. ● DALI address can be manually assigned and shown in digital display or automatically assigned by DALI master. ● To switch LED lamps, traditional incandescent and halogen lights. 	DALI PC Host:Assign DALI address, dimming ontrol DALI Master Control Panel:TS4-D,DA-4S WiFi APP Control:DA-M(WT),TD-K(WT) Zigbee Control:DA-M(WZ),TD-K(WZ)	/
DH1	DALI AC Switch		Input voltage:100-240VAC Relay output:10A resistive load (incandescent lamp) 8A Capacitive load (LED dimming driver) 5A inductive load (Buorescent lamp) Proudct size:131x37x20.5mm(LxWxH)	<ul style="list-style-type: none"> ● 1 DALI address,1 channel output. ● DALI address will be automatically assigned by DALI master. ● 10A dry contact mains rated relay output. 	DALI PC Host:Assign DALI address, dimming ontrol DALI Master Control Panel:TS4-D,DA-4S WiFi APP Control:DA-M(WT),TD-K(WT) Zigbee Control:DA-M(WZ),TD-K(WZ)	/
DH4	DALI/DMX 4-Channel Relay Switch		Input voltage:100-240VAC Input signal:DALI/DMX512 Relay output:16A resistive load (incandescent lamp) 8A Capacitive load (LED dimming driver) 8A inductive load (Guorescent lamp) Proudct size:115x88x65mm(LxWxH)	<ul style="list-style-type: none"> ● Supports DALI,DMX512 or manual switch three kinds of working modes. ● OLED dispaly screen,3 button setting. ● 4 DALI address, 4 channel 16A dry contact mains rated relay output. ● DALI address can be manually assigned and shown in digital display or automatically assigned by DALI master. ● 4-button manual switch for 4 channels. ● Can be configured for 4 independent channels, 2 groups of 2 channels and 1 group of 4 channels. ● Standard rail mount. 	DALI PC Host:Assign DALI address, dimming ontrol DALI Master Control Panel:TS4-D,DA-4S WiFi APP Control:DA-M(WT),TD-K(WT) Zigbee Control:DA-M(WZ),TD-K(WZ)	DH4, DH8 Contrast: Common: 1. Supports DALI,DMX512 or manual switch three kinds of working modes. 2. DALI address can be manually assigned and shown in digital display or automatically assigned by DALI master. 3. Work Voltage:100-240VAC, dry contact relay output.
DH8	DALI/DMX 8-Channel Relay Switch		Input voltage:100-240VAC Input signal:DALI/DMX512 Relay output:16A resistive load (incandescent lamp) 8A Capacitive load (LED dimming driver) 8A inductive load (Buorescent lamp) Proudct size:149x88x60mm(LxWxH)	<ul style="list-style-type: none"> ● Supports DALI,DMX512 or manual switch three kinds of working modes. ● Digital display,3 button setting. ● 8 DALI address, 8 channel 16A dry contact mains rated relay output. ● DALI address can be manually assigned and shown in digital display or automatically assigned by DALI master. ● Configurable for 8 independent channels, 4 groups of 2 channels and 2 groups of 4 channels for use. ● Standard rail mount. 	DALI PC Host:Assign DALI address, dimming ontrol DALI Master Control Panel:TS4-D,DA-4S WiFi APP Control:DA-M(WT),TD-K(WT) Zigbee Control:DA-M(WZ),TD-K(WZ)	Difference: 1. Appearance and buttons are different: DH8 With 3 setting keys. DH4 has 4 manual on/off keys in addition to the 3 setup keys. 2. Size difference: DH4 Size:115x88x65mm(LxWxH) DH8 Size:149x88x60mm(LxWxH)

DALI Constant Voltage LED Driver



Model Name	Product Name	Pictrue	Parameters	Key Feature	Recommended Products	Distinguish Between Similar Products
LPV-150DA-12	150W 12V DALI Dimming Constant Voltage LED Driver		Input voltage:100-240VAC Power factor:>0.95 Output voltage:12VDC Output current:Max. 12.5A Output power:Max. 150W Proudct size:310x45x30mm(LxWxH)	<ul style="list-style-type: none"> ● 1 DALI address,1 channel constant voltage output. ● DALI address will be automatically assigned by DALI master. ● Connect with AC push switch to achieve on/off and dimming function. 	DALI PC Host:Assign DALI address, dimming ontrol DALI Master Control Panel:TD1-S,TD1-4S,TD-K,TS4-D WiFi APP Control:DA-M(WT),TD-K(WT) Zigbee Control:DA-M(WZ),TD-K(WZ)	/
LPV-150DA-24	150W 24V DALI Dimming Constant Voltage LED Driver		Input voltage:100-240VAC Power factor:>0.95 Output voltage:24VDC Output current:Max. 6.25A Output power:Max. 150W Proudct size:310x45x30mm(LxWxH)	<ul style="list-style-type: none"> ● 1 DALI address,1 channel constant voltage output. ● DALI address will be automatically assigned by DALI master. ● Connect with AC push switch to achieve on/off and dimming function. 	DALI PC Host:Assign DALI Address, Dimming Control DALI Master Control Panel:TD1-S,TD1-4S,TD-K,TS4-D WiFi APP Control:DA-M(WT),TD-K(WT) Zigbee Control:DA-M(WZ),TD-K(WZ)	/



DALI Dimming Constant Current LED Driver

Model Name	Product Name	Pictrue	Parameters	Key Feature	Recommended Products	Distinguish Between Similar Products
DA-12A	12W DALI Dimming Constant Current LED Driver		Input voltage:100-240VAC Power factor:>0.95 Output voltage:10-42VDC Output current:100-700mA Output power:Max. 12W Proudct size:131x37x20.5mm(LxWxH)	<ul style="list-style-type: none"> ● 1 DALI address,1 channel constant current output. ● DALI address will be automatically assigned by DALI master. ● 13 current levels(100-700mA, 50mA intervals),wide voltage output for different power LEDs. ● Connect with AC push switch to achieve on/off and dimming function. 	DALI PC Host:Assign DALI address, dimming ontrol DALI Master Control Panel:TD1-S,TD1-4S,TD-K,TS4-D WiFi APP Control:DA-M(WT),TD-K(WT) Zigbee Control:DA-M(WZ),TD-K(WZ)	/

DA-30A	30W DALI Dimming Constant Current LED Driver		Input voltage:100-240VAC Power factor:>0.95 Output voltage:10-42VDC Output current:150-900mA Output power:Max. 30W Proudct size:149x45x24mm (LxWxH)	<ul style="list-style-type: none"> ● 1 DALI address,1 channel constant current output. ● DALI address will be automatically assigned by DALI master. ● 15 current levels(150-900mA,50mA intervals),wide voltage output for different power LEDs. 	DALI PC Host:Assign DALI address, dimming ontrol DALI Master Control Panel:TD1-S, TD1-4S, TD-K, TS4-D WiFi APP Control:DA-M(WT), TD-K(WT) Zigbee Control:DA-M(WZ), TD-K(WZ)	/
DA-40A	40W DALI Dimming Constant Current LED Driver		Input voltage:100-240VAC Power factor:>0.95 Output voltage:10-42VDC Output current:250-1000mA Output power:Max. 40W Proudct size:149x45x24mm (LxWxH)	<ul style="list-style-type: none"> ● 1 DALI address,1 channel constant current output. ● DALI address will be automatically assigned by DALI master. ● 15 current levels(250-1000mA,50mA intervals),wide voltage output for different power LEDs. 	DALI PC Host:Assign DALI address, dimming ontrol DALI Master Control Panel:TD1-S, TD1-4S, TD-K, TS4-D WiFi APP Control:DA-M(WT), TD-K(WT) Zigbee Control:DA-M(WZ), TD-K(WZ)	/
DA-12A-2	12W DALI Color Temperature Constant Current LED Driver (DT8)		Input voltage:100-240VAC Power factor:>0.95 Output voltage:10-42VDC Output current:100-450mA Output power:Max. 12W Proudct size:131x37x20.5mm (LxWxH)	<ul style="list-style-type: none"> ● 1 DALI address,2 channel constant current output. ● DALI address will be automatically assigned by DALI master. ● 8 current levels(100-450mA,50mA intervals),wide voltage output for different power LEDs. 	DALI PC Host:Assign DALI address, dimming ontrol DALI Master Control Panel:TD2-S, TD2-4S, TD-K WiFi APP Control:DA-M(WT), TD-K(WT) Zigbee Control:DA-M(WZ), TD-K(WZ)	/
DA-20A-2	20W DALI Color Temperature Constant Current LED Driver (DT8)		Input voltage:100-240VAC Power factor:>0.95 Output voltage:10-42VDC Output current:100-800mA Output power:Max. 20W Proudct size:149x45x24mm (LxWxH)	<ul style="list-style-type: none"> ● 1 DALI address,2 channel constant current output. ● DALI address will be automatically assigned by DALI master. ● 15 current levels(100-800mA,50mA intervals),wide voltage output for different power LEDs. 	DALI PC Host:Assign DALI address, dimming ontrol DALI Master Control Panel:TD2-S, TD2-4S, TD-K WiFi APP Control:DA-M(WT), TD-K(WT) Zigbee Control:DA-M(WZ), TD-K(WZ)	/
DA-30A-2	30W DALI Color Temperature Constant Current LED Driver (DT8)		Input voltage:100-240VAC Power factor:>0.95 Output voltage:10-42VDC Output current:150-900mA Output power:Max. 30W Proudct size:149x45x24mm (LxWxH)	<ul style="list-style-type: none"> ● 1 DALI address,2 channel constant current output. ● DALI address will be automatically assigned by DALI master. ● 15 current levels(150-900mA,50mA intervals),wide voltage output for different power LEDs. 	DALI PC Host:Assign DALI address, dimming ontrol DALI Master Control Panel:TD2-S, TD2-4S, TD-K WiFi APP Control:DA-M(WT), TD-K(WT) Zigbee Control:DA-M(WZ), TD-K(WZ)	/
DA-40A-2	40W DALI Color Temperature Constant Current LED Driver (DT8)		Input voltage:100-240VAC Power factor:>0.95 Output voltage:10-42VDC Output current:250-1000mA Proudct size:149x45x24mm (LxWxH)	<ul style="list-style-type: none"> ● 1 DALI address,2 channel constant current output. ● DALI address will be automatically assigned by DALI master. ● 15 current levels(250-1000mA,50mA intervals),wide voltage output for different power LEDs. 	DALI PC Host:Assign DALI address, dimming ontrol DALI Master Control Panel:TD2-S, TD2-4S, TD-K WiFi APP Control:DA-M(WT), TD-K(WT) Zigbee Control:DA-M(WZ), TD-K(WZ)	/

DALI Dimming Constant Current LED Magnetic Lamp Driver

Model Name	Product Name	Pictrue	Parameters	Key Feature	Recommended Products	Distinguish Between Similar Products
CXD-21A	DALI Dimming Constant Current LED Magnetic Lamp Driver (150-500mA)		Input voltage:48VDC Output voltage:10-40VDC Output current:150-500mA Output power:Max. 20W Proudct size:125x9.5x7.5mm (LxWxH)	<ul style="list-style-type: none"> ● 1 DALI address,1 channel constant current output. ● DALI address will be automatically assigned by DALI master. ● No input polarity. ● DC to DC constant current output,8 levels current selectable(150-500mA,50mA intervals). 	DALI PC Host:Assign DALI address, dimming ontrol DALI Master Control Panel:TD1-S, TD1-4S, TD-K, TS4-D WiFi APP Control:DA-M(WT), TD-K(WT) Zigbee Control:DA-M(WZ), TD-K(WZ)	CXD-21A, CXD-28A Contrast: Common: 1. Single channel dimming, occupies 1 DALI address. 2. Same size, output current selected by DIP switch.
CXD-28A	DALI Dimming Constant Current LED Magnetic Lamp Driver (350-700mA)		Input voltage:48VDC Output voltage:10-40VDC Output current:350-700mA Output power:Max. 28W Proudct size:125x9.5x7.5mm (LxWxH)	<ul style="list-style-type: none"> ● 1 DALI address,1 channel constant current output. ● DALI address will be automatically assigned by DALI master. ● No input polarity. ● DC to DC constant current output,8 levels current selectable(350-700mA,50mA intervals). 	DALI PC Host:Assign DALI address, dimming ontrol DALI Master Control Panel:TD1-S, TD1-4S, TD-K, TS4-D WiFi APP Control:DA-M(WT), TD-K(WT) Zigbee Control:DA-M(WZ), TD-K(WZ)	Difference: Output current, output power are different. CXD-21A Max. output 20W, CXD-28A Max. output 28W.

CXD-21A-2	DALI Color Temperature Constant Current LED Magnetic Lamp Driver (150-500mA)		Input voltage:48VDC Output voltage:10-40VDC Output current:150-500mA Output power:Max. 20W Proudct size:125x9. 5x7. 5mm (LxWxH)	<ul style="list-style-type: none"> ● 1 DALI address,2 channel constant current output. ● DALI address will be automatically assigned by DALI master. ● No input polarity. ● DC to DC constant current output,8 levels current selectable(150-500mA, 50mA intervals). 	DALI PC Host:Assign DALI address, dimming ontrol DALI Master Control Panel:TD2-S, TD2-4S, TD-K WiFi APP Control:DA-M(WT), TD-K(WT) Zigbee Control:DA-M(WZ), TD-K(WZ)	<p>CXD-21A-2, CXD-28A-2 Contrast:</p> <p>Common:</p> <ol style="list-style-type: none"> 1. Dual-channel color temperature dimming, supports DT8-TC, occupies 1 address. 2. Same size, output current selected by DIP switch. <p>Difference:</p> <p>Output current, output power are different. CXD-21A-2 Max. output 20W, CXD-28A-2 Max. output 28W.</p>
CXD-28A-2	DALI Color Temperature Constant Current LED Magnetic Lamp Driver (350-700mA)		Input voltage:48VDC Output voltage:10-40VDC Output current:350-700mA Output power:Max. 28W Proudct size:125x9. 5x7. 5mm (LxWxH)	<ul style="list-style-type: none"> ● 1 DALI address,2 channel constant current output. ● DALI address will be automatically assigned by DALI master. ● No input polarity. ● DC to DC constant current output,8 levels current selectable(350-700mA, 50mA intervals). 	DALI PC Host:Assign DALI address, dimming ontrol DALI Master Control Panel:TD2-S, TD2-4S, TD-K WiFi APP Control:DA-M(WT), TD-K(WT) Zigbee Control:DA-M(WZ), TD-K(WZ)	