









PIR Human Motion Sensor Switch

Model Name	Product Name	Pictrue	Parameters	Key Feature	Recommended Products	Distinguish Between Similar Products
E1-R	PIR Sensor Switch Constant Voltage LED Controller		Input/Output voltage:12-24VDC Output power:Max.36W@12V Max.72W@24V Sensing range:≤3m Delay time:30s (default) Proudct size:50x11x12mm(LxWxH)	<ul style="list-style-type: none"> ● When entering the sensing range, the light turns on; when leaving the sensing range, the light turns off after 30 seconds. ● Usually installed in the LED light strip aluminum housing,PCB bottom 3M adhesive mounting. ● Widely used in table lamps,bedroom lamps,wardrobe lights,etc. 	/	/
ER-AV	PIR Sensor Switch Constant Voltage LED Controller		Input/Output voltage:5-24VDC Output current1.5A Output power:Max.18W@12V Max.36W@24V Sensing range:≤3-4m Sensing angle:120° Delay time:30s (default) Proudct size:20x18.5mm(DxH)	<ul style="list-style-type: none"> ● Dupont male jack in, dupont female jack out. ● When entering the sensing range, the light turns on; when leaving the sensing range, the light turns off after 30 seconds. ● Concealed installation,bilateral snap design,applied to staircase,cabinet, closet,wine cooler and other lighting. 	LED Control Box:CVO	/
EV-R	PIR Sensor+RF Dimming Constant Voltage LED Controller		Input/Output voltage:5-24VDC Output current:3A Input signal:PIR Sensor,RF 2.4GHz Control distance:30m(Barrier-free space) Dimming range:10-100% Sensing range:2-7m Sensing angle:120° Proudct size:80x40x29mm(LxWxH)	<ul style="list-style-type: none"> ● PIR motion sensor dimming controller with daylight detection. ● 3 button operation, 6 indicator lights. ● 3 work modes(Lights on, lights off, auto-sensor). ● 5 level dimmer(10%,25%,50%,75%,100%). ● 6 level timer(10/30/60/180/300/600s). ● DIP switch on or off daylight detection. ● Optional RF 2.4G single-zone or multi-zone dimming remote control. ● It can be used as an inductive RF remote control to remotely switch other RF LED controllers or RF dimming drivers. ● 3M tape installation,easy and convenient. 	Dimming RF Remote Control:R11,R1-1,R1,R6-1,R6,RT1,RT6,RS1 Dimming Panel RF Remote Control:RK1,TW1,T21,T11-S,T11-1,T11-K RF Dimming Constant Voltage LED Controller:V1,V1-L,V1-C,V1-M,V1-W RF Dimming Constant Voltage LED Driver:PB-75-24,PH-150-24 RF Dimming Constant Current LED Driver:PB-12A-L(WT) RF High Voltage LED Strip Controller:S1-HV,S3,S3(WT) RF Triac Dimmer:S1-B,S1-B(WT),S1-F RF 0/1-10V Dimmer:L1,L1(WT) RF-DALI Signal Converter:DA-M	/
EH-R	PIR Sensor 0/1-10V Dimmer & AC Switch		Input voltage:100-240VAC Output signal:0/1-10V(Max.30mA), RF 2.4GHz Output current:Max.4A (AC) Detection zone:Max.10x5m(DxH) Detection angle:120° (ceiling installation) Proudct size:95x51mm(DxH)	<ul style="list-style-type: none"> ● Ceiling mounting PIR motion detectors, built-in daylight sensor. ● Output 1 channel 0/1-10V signal, connect with 0/1-10V dimmable driver. ● DIP switch selects 0-10V or 1-10V output. ● 1 relay switch AC output. ● Delay time (7 levels) and daylight threshold (7 levels) can be set with the knob. ● Three sensor switch modes can be selected by DIP switch and knob: non-dimming sensor switch,two-stage dimming sensor switch,and constant illumination sensor switch. ● Work as RF remote, output RF 2.4G signal,matched with RF LED controller or RF dimmable LED driver optional. 	0-10V Constant Voltage LED Controller:LV,LV-L 0-10V Triac Dimmer:S1-L 0-10V Dimming Constant Voltage LED Driver:LPV-150M-24 0-10V Dimming Constant Current LED Driver:LF-12A,LF-20A RF Dimming Constant Voltage LED Controller:V1,V1-L,V1-C,V1-M,V1-W RF Dimming Constant Voltage LED Driver:PB-75-24,PH-150-24 RF Dimming Constant Current LED Driver:PB-12A-L(WT) RF High Voltage LED Strip Controller:S1-HV,S3,S3(WT) RF Triac Dimmer:S1-B,S1-B(WT),S1-F	/

Touch Sensor Switch

Model Name	Product Name	Pictrue	Parameters	Key Feature	Recommended Products	Distinguish Between Similar Products
E1-C	Touch Dimming Constant Voltage LED Controller		Input/Output voltage:12-24VDC Output power:Max.36W@12V Max.72W@24V PWM Frequency:128Hz Proudct size:50x7.8x10mm(LxWxH)	<ul style="list-style-type: none"> ● Red and black wire inputs and outputs,connect with 5 meters single color LED strip. ● High sensitivity touch operation with LED indicator. ● Short press to turn the light on or off,long press to adjust the brightness. ● The media on the touch spring can be PC cover,acrylic board or mirror glass. ● Usually installed in the LED light bar aluminum channel,PCB bottom 3M adhesive mounting. 	/	/
EC-AV	Touch Dimming Constant Voltage LED Controller		Input/Output voltage:5-24VDC Output current:2.5A Output power:Max.30W@12V Max.60W@24V PWM Frequency:125Hz (default) Proudct size:20x18.5mm(DxH)	<ul style="list-style-type: none"> ● Dupont male jack in, dupont female jack out. ● High sensitivity touch operation with LED indicator. ● Short press to turn the light on or off,long press to adjust the brightness. ● Four PWM frequencies (125,500,2K,8KHz) are set by pressing multiple times in quick succession at the moment of power-up. ● Concealed installation,bilateral snap design,applied to staircase,cabinet,closet,wine cabinet and other lighting. 	LED Control Box:CVO	/

Hand Sweep Sensor Switch

Model Name	Product Name	Pictrue	Parameters	Key Feature	Recommended Products	Distinguish Between Similar Products
E1-B	Hand Sweep Sensor Switch Constant Voltage LED Controller		Input/Output voltage:12-24VDC Output current:Max.4A Output power:Max.48W@12V Max.96W@24V Sensing range:≤8cm Sensing angle:15-30 PWM Frequency:2KHz (default) Proudct size:50x11x9mm(LxWxH)	<ul style="list-style-type: none"> ● When hand sweep, the light turn on gradually.When hand sweep again,the light turn off gradually. ● When hold hand for more than 2 seconds,adjust the brightness. ● Usually installed in the LED light strip aluminum housing,PCB bottom 3M adhesive mounting. ● Widely used in table lamps,bedroom lamps,wardrobe lights,etc. 	/	/
E2-B	Hand Sweep Sensor Switch Color Temperature Constant Voltage LED Controller		Input/Output voltage:12-24VDC Output current:Max.3A Output power:Max.36W@12V Max.72W@24V Sensing range:≤6cm Sensing angle:15-30 PWM Frequency:2KHz (default) Proudct size:52x10x5.3mm(LxWxH)	<ul style="list-style-type: none"> ● Dedicated to color temperature LED low voltage strip. ● Hold your hand in front of the sensor head for a short time (less than 1 second) to turn on or off the light. ● Hold your hand in front of the sensor head for a long time (more than 1 second) adjust the brightness or color temperature continuously. ● Each time you wave your hand (less than 0.5 second), switch the brightness adjustment or color temperature adjustment. ● 2 push switch can be connected. one push switch for short press switch, long press to adjust the brightness continuously, another push switch for short press to switch the 3-level color temperature sequentially, long press to adjust the color temperature continuously. ● Usually installed in the LED light strip aluminum housing,PCB bottom 3M adhesive mounting. ● Widely used in table lamps,bedroom lamps,wardrobe lights,etc 	/	/

EB-CV (D)	Hand Sweep Sensor Switch Constant Voltage LED Controller		Input/Output voltage:12-24VDC Output current:Max. 4A Output power:48-96W Sensing range:≤7cm Dimming range:5-100% Dimming curve:Logarithmic PWM Frequency:2KHz (default) Proudct size:26x18mm (DxH)	<ul style="list-style-type: none"> ● DC female input,DC male output. ● When hand sweep, the light turn on gradually.When hand sweep again, the light turn off gradually. ● 1 second light on/off fade. ● Adjust the brightness by holding your hand in front of the sensor head for more than 2s. ● Concealed installation,bilateral snap design,applied to staircase,cabinet, closet,wine cabinet and other lighting. 	/	/
EB-CV (L)	Hand Sweep Sensor Switch Constant Voltage LED Controller		Input/Output voltage:12-24VDC Output current:Max. 4A Output power:48-96W Sensing range:≤7cm Dimming range:5-100% Dimming curve:Logarithmic PWM Frequency:2KHz (default) Proudct size:26x18mm (DxH)	<ul style="list-style-type: none"> ● Dupont wire male input,Dupont wire female output. ● When hand sweep, the light turn on gradually.When hand sweep again, the light turn off gradually. ● 1 second light on/off fade. ● Adjust the brightness by holding your hand in front of the sensor head for more than 2s. ● Concealed installation,bilateral snap design,applied to staircase,cabinet, closet,wine cabinet and other lighting. 	LED Control Box:CVO	/
EB-V (C)	Hand Sweep Sensor Switch Constant Voltage LED Controller		Input/Output voltage:12-24VDC Output current:Max. 1A Output power:12-24W Sensing range:≤8cm Dimming range:5-100% Dimming curve:Logarithmic PWM Frequency:2KHz (default) Proudct size:13x32.3mm (DxH)	<ul style="list-style-type: none"> ● Three-wire inputs and outputs with common positive polarity. ● When hand sweep, the light turn on gradually.When hand sweep again, the light turn off gradually. ● 1 second light on/off fade. ● Adjust the brightness by holding your hand in front of the sensor head for more than 2s. ● Can be installed openly or concealed, applied to cabinet,closet,wine cabinet and other lighting. 	/	/

Door Sensor Switch



Model Name	Product Name	Pictrue	Parameters	Key Feature	Recommended Products	Distinguish Between Similar Products
E1-D	Door Sensor Switch Constant Voltage LED Controller		Input/Output voltage:12-24VDC Output current:Max. 4A Output power:Max. 48W@12V Max. 96W@24V Sensing range:≤10cm Sensing angle:15-30 Proudct size:50x11x7.5mm (LxWxH)	<ul style="list-style-type: none"> ● When the door open,or no obstacle ahead, the light turn on gradually. When the door close,or obstacle ahead,the light turn off gradually. ● Usually installed in the LED light strip aluminum housing,PCB bottom 3M adhesive mounting. ● Widely used in wardrobe lights. 	/	/
ED-CV (D)	Door Sensor Switch Constant Voltage LED Controller		Input/Output voltage:12-24VDC Output current:Max. 4A Output power:48-96W Sensing range:≤5cm PWM Frequency:2KHz Proudct size:26x18mm (DxH)	<ul style="list-style-type: none"> ● DC female input,DC male output. ● When the door open,or no obstacle ahead,the light turn on gradually. When the door close,or obstacle ahead, the light turn off gradually. ● 1 second light on/off fade. ● Concealed aluminum housing,applied to cabinet,closet,wine cabinet and other lighting. 	/	/
ED-CV (L)	Door Sensor Switch Constant Voltage LED Controller		Input/Output voltage:12-24VDC Output current:Max. 4A Output power:48-96W Sensing range:≤5cm PWM Frequency:2KHz Proudct size:26x18mm (DxH)	<ul style="list-style-type: none"> ● Dupont wire male input,Dupont wire female output. ● When the door open, or no obstacle ahead, the light turn on gradually. When the door close,or obstacle ahead,the light turn off gradually. ● 1 second light on/off fade. ● Concealed aluminum housing, applied to cabinet,closet,wine cabinet and other lighting. 	LED Control Box:CVO	/
ED-V (C)	Door Sensor Switch Constant Voltage LED Controller		Input/Output voltage:12-24VDC Output current:Max. 1A Output power:12-24W Sensing range:≤6cm PWM Frequency:2KHz Proudct size:13x32.3mm (DxH)	<ul style="list-style-type: none"> ● Three-wire inputs and outputs with common positive polarity. ● When the door open, or no obstacle ahead, the light turn on gradually. When the door close,or obstacle ahead,the light turn off gradually. ● 1 second light on/off fade. ● Can be installed openly or concealed, applied to cabinet,closet,wine cabinet and other lighting. 	/	/

Microwave Sensor Switch



Model Name	Product Name	Pictrue	Parameters	Key Feature	Recommended Products	Distinguish Between Similar Products
EH-M	Microwave Sensor 0/1-10V Dimmer & AC Switch		Input voltage:100-240VAC Output signal:0/1-10V (Max. 30mA), RF 2.4GHz Output current:Max 4A (AC) Detection zone:Max. 20x10m (DxH) Detection angle:360° (ceiling installation) Proudct size:95x95x40mm (LxWxH)	<ul style="list-style-type: none"> ● 10.525GHz Ceiling mounting microwave motion detectors,built-in daylight sensor. ● Output 1 channel 0/1-10V signal,to control 0/1-10V LED controller or dimming driver. ● DIP switch selects 0-10V or 1-10V output. ● 1 relay switch AC output. ● Set the detection range (5 levels), delay time (7 levels) and daylight threshold (7 levels) with the knobs. ● Press the button to select three sensor switch modes: non-dimming sensor switch, two-stage dimming sensor switch, and constant illumination sensor switch. ● Work as RF remote,matched with RF LED controller or RF dimmable LED driver optional. 	0-10V Constant Voltage LED Controller:LV, LV-L 0-10V Triac Dimmer:S1-L 0-10V Dimming Constant Voltage LED Driver:LPV-150M-24 0-10V Dimming Constant Current LED Driver:LF-12A, LF-20A RF Dimming Constant Voltage LED Controller:V1, V1-L, V1-C, V1-M, V1-W RF Dimming Constant Voltage LED Driver:PB-75-24, PH-150-24 RF Dimming Constant Current LED Driver:PB-12A-L (WT) RF High Voltage LED Strip Controller:S1-HV, S3, S3 (WT) RF Triac Dimmer:S1-B, S1-B (WT), S1-F	/

EH-M(WZ)	Zigbee Microwave Sensor Switch		<p>Input voltage:100-240VAC Output signal:Zigbee 3.0, RF 2.4GHz, 0/1-10V (Max. 30mA) Output current:Max 4A (AC) Detection zone:Max. 20x10m(DxH) Detection angle:360° (ceiling installation) Proudct size:95x95x40mm(LxWxH)</p>	<ul style="list-style-type: none"> ● 10.525GHz Ceiling mounting microwave motion detectors, built-in daylight sensor. ● Tuya APP cloud control, support motion detection sensitivity, light sensitivity, time delay on/off, timer operation. ● Output Zigbee 3.0 signal, intelligent linkage to turn on/off other Tuya Zigbee or WiFi series lighting controllers. ● Output 1 channel 0/1-10V signal, to control 0/1-10V LED controller or dimming driver. ● 1 relay switch AC output. ● Work as RF remote, matched with RF LED controller or RF dimmable LED driver optional. 	<p>Zigbee Constant Voltage LED Controller:WZS2, WZ1, WZ5 Zigbee Triac Dimmer:S1-B(WZ), S1-F(WZ) Zigbee AC Switch:SS-L(WZ), SS-B(WZ) Zigbee Constant Current LED Driver:PB-12A-L(WZS), CXR-21A(WZS) Zigbee Gateway:WG-Z</p> <p>0-10V Constant Voltage LED Controller:LV, LV-L 0-10V Triac Dimmer:S1-L 0-10V Dimming Constant Voltage LED Driver:LPV-150M-24 0-10V Dimming Constant Current LED Driver:LF-12A, LF-20A</p> <p>RF Dimming Constant Voltage LED Controller:V1, V1-L, V1-C, V1-M, V1-W RF Dimming Constant Voltage LED Driver:PB-75-24, PH-150-24 RF Dimming Constant Current LED Driver:PB-12A-L(WT) RF High Voltage LED Strip Controller:S1-HV, S3, S3(WT) RF Triac Dimmer:S1-B, S1-B(WT), S1-F</p>	/
----------	--------------------------------	---	---	--	--	---

Cabinet Constant Voltage LED Driver(non-dimming)

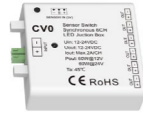
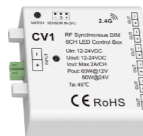

Model Name	Product Name	Pictrue	Parameters	Key Feature	Recommended Products	Distinguish Between Similar Products
PBL-60-12	60W 12V Constant Voltage LED Driver		<p>Input voltage:100-240VAC Output voltage:12VDC Output current:Max. 5.0A Output power:Max. 60W Proudct size:164x55x18mm(LxWxH)</p>	<ul style="list-style-type: none"> ● 1 channel constant voltage output, Max. total output power 60W. ● Can be used as a separate non-dimmable constant voltage LED driver to directly drive constant voltage LED low voltage strips. ● Used in conjunction with a 6 CH LED synchronization control box to drive multiple constant voltage LED strips for RF remote control or various inductive controls. 	Synchronous 6CH LED Control Box:CV0, CV1, CV1(WT), CV2	/
PBL-60-24	60W 24V Constant Voltage LED Driver		<p>Input voltage:100-240VAC Output voltage:24VDC Output current:Max. 2.5A Output power:Max. 60W Proudct size:164x55x18mm(LxWxH)</p>	<ul style="list-style-type: none"> ● 1 channel constant voltage output, Max. total output power 60W. ● Can be used as a separate non-dimmable constant voltage LED driver to directly drive constant voltage LED low voltage strips. ● Used in conjunction with a 6 CH LED synchronization control box to drive multiple constant voltage LED strips for RF remote control or various inductive controls. 	Synchronous 6CH LED Control Box:CV0, CV1, CV1(WT), CV2	/

Synchronous 6CH LED Control Box

Model Name	Product Name	Pictrue	Parameters	Key Feature	Recommended Products	Distinguish Between Similar Products
CV0	Sensor Dimming Synchronous 6CH LED Control Box		<p>Input/Output voltage:12-24VDC Output power:Max. 60W Proudct size:54x55x18mm(LxWxH)</p>	<ul style="list-style-type: none"> ● Dimming interface:sensor. ● 6 channel synchronous constant voltage output, Max. total output power 60W. ● Supports multiple sensor head inputs. 	<p>Cabinet Constant Voltage LED Driver:PBL-60-12, PBL-60-24</p> <p>Sensor Head:PIR human motion, touch, hand sweep, door control, microwave</p>	/
CV1	RF+Sensor Dimming Synchronous 6CH LED Control Box		<p>Input/Output voltage:12-24VDC Output current:6CH, Max. 2A/CH Output power:Max. 60W Input signal:RF 2.4GHz, Sensor Control distance:30m(Barrier free space) Dimming curve:Logarithmic PWM Frequency:2KHz(default) Proudct size:54x55x18mm(LxWxH)</p>	<ul style="list-style-type: none"> ● Dimming interface: RF Wireless, Sensor. ● 6 channel synchronous constant voltage output, Max. total output power 60W. ● Match with RF 2.4G single zone or multiple zone dimming remote control. ● Supports multiple sensor head inputs. ● Light on/off fade time 3s selectable. 	<p>Cabinet Constant Voltage LED Driver:PBL-60-12, PBL-60-24</p> <p>Sensor Head:PIR human motion, touch, hand sweep, door control, microwave</p> <p>Dimming RF Remote Control:R11, R1-1, R1, R6-1, R6, RT1, RT6, RS1 Dimming Panel RF Remote Control:RK1, TW1, T21, T11-S, T11-1, T11-K</p>	/
CV1(WT)	WiFi+RF+Sensor Dimming Synchronous 6CH LED Control Box		<p>Input/Output voltage:12-24VDC Output current:6CH, Max. 2A/CH Output power:Max. 60W Input signal:WiFi, RF 2.4GHz, Sensor Control distance:30m(Barrier free space) Dimming curve:Logarithmic PWM Frequency:2KHz(default) Proudct size:54x55x18mm(LxWxH)</p>	<ul style="list-style-type: none"> ● Dimming interface: WiFi, RF Wireless and Sensor. ● 6 channel synchronous constant voltage output, Max. total output power 60W. ● Tuya APP cloud control, support brightness adjust, delay turn on/off light, timer run, scene edit function. ● Voice control, support for Amazon Alexa, Google Assistant, Tmall Genie and Xiaodu smart speakers. ● Match with RF 2.4G single zone or multiple zone dimming remote control. ● Supports multiple sensor head inputs. ● Light on/off fade time 3s selectable. 	<p>Cabinet Constant Voltage LED Driver:PBL-60-12, PBL-60-24</p> <p>Sensor Head:PIR human motion, touch, hand sweep, door control, microwave</p> <p>Dimming RF Remote Control:R11, R1-1, R1, R6-1, R6, RT1, RT6, RS1 Dimming Panel RF Remote Control:RK1, TW1, T21, T11-S, T11-1, T11-K</p>	/
CV2	RF+Sensor Dimming Synchronous 6CH Color Temperature LED Control Box		<p>Input/Output voltage:12-24VDC Output current:6CH, Max. 2A/CH Output power:Max. 60W Input signal:RF 2.4GHz, Sensor Control distance:30m(Barrier free space) Proudct size:54x55x18mm(LxWxH)</p>	<ul style="list-style-type: none"> ● Only apply to 2-wires WW+CW LED strip. ● Dimming interface: RF Wireless, Sensor. ● 6 channel synchronous constant voltage output, Max. total output power 60W. ● Match with RF 2.4G single zone or multiple zone dual color remote control. ● Supports multiple sensor head inputs. ● Light on/off fade time 3s selectable. 	<p>Cabinet Constant Voltage LED Driver:PBL-60-12, PBL-60-24</p> <p>Sensor Head:PIR human motion, touch, hand sweep, door control, microwave</p> <p>Color Temperature RF Remote Control:R12, R7-1, R7, RT2, RT7, RS2 Color Temperature Panel RF Remote Control:RK2, TW2, T22, T12-S, T12-1</p>	/

Sensor Head Input Constant Voltage LED Controller Or Switch

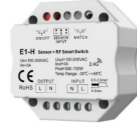
Model Name	Product Name	Pictrue	Parameters	Key Feature	Recommended Products	Distinguish Between Similar Products
E1-L	Sensor Head Input Constant Voltage LED Controller		<p>Input/Output voltage:12-48VDC Output current:8A Proudct size:97x33x18mm(LxWxH)</p>	<ul style="list-style-type: none"> ● Single sensor input, single channel constant voltage output, output connected to the low voltage LED strip. ● Compatible with multiple sensor heads, include PIR human motion sensor, touch sensor, hand sweep sensor, door sensor, microwave motion detector etc. 	Sensor Head:PIR human motion, touch, hand sweep, door control, microwave	/

E1-H	Sensor Head Input + RF AC Switch		<p>Input/Output voltage:100-240VAC Output current:Max. 3A Input signal:RF 2.4GHz, Sensor Control distance:30m(Barrier free space) Proudct size:52x52x26mm(LxWxH)</p>	<ul style="list-style-type: none"> ● Single sensor input,single channel relay AC switch output. ● Compatible with multiple sensor heads,include PIR human motion sensor,touch sensor,hand sweep sensor,door sensor,microwave motion detector etc. ● RF 2.4G remote control is available as an option for all sensor inputs except PIR human motion sensor input. ● Works as an sensor-RF signal converter,synchronizing one or more RF LED controllers. 	<p>Sensor Head:PIR human motion,touch,hand sweep,door control,microwave RF Remote Control:R1-1,RU4,RU8,PF1-2</p>	/
ES-V	Dual PIR Sensor + Push Switch Dimming & CCT Constant Voltage LED Controller		<p>Input voltage:12-48VDC Output voltage:2x(12-48)VDC Output current:2x6A@12/24V 2x4A@36/48V Input signal:Sensor,Push switch PWM Frequency:2KHz(default) Proudct size:115x46x16mm(LxWxH)</p>	<ul style="list-style-type: none"> ● Dual sensor inputs,compatible with a variety of sensor heads, including PIR human motion sensor,door sensor,hand sweep sensor,door sensor,microwave motion detector etc. ● 2 channel constant voltage output for controll single color or color temperature LED low voltage strips. ● 2-in-1 function, DIP switch set dimming or color temperature light type. ● Connect the self-reset switch for on/off,brightness and color temperature adjustment. ● DIP switch set 4 levels of delayed light off time(0/30/60/180s). ● DIP switch turns daylight detection on or off. 	<p>Sensor Head:PIR human motion,touch,hand sweep,door control,microwave Stair Light Controller Sensor Head:ER-C,ES-T</p>	/